

Latitude 9450 2-in-1

Owner's Manual

Notes, cautions, and warnings

 **NOTE:** A NOTE indicates important information that helps you make better use of your product.

 **CAUTION:** A CAUTION indicates either potential damage to hardware or loss of data and tells you how to avoid the problem.

 **WARNING:** A WARNING indicates a potential for property damage, personal injury, or death.

Chapter 1: Views of Latitude 9450 2-in-1	6
Right	6
Left	6
Top	8
Front	10
Bottom	11
Service Tag	11
Modes	12
Battery-charge status light	14
Chapter 2: Set up your Latitude 9450 2-in-1	15
Chapter 3: Specifications of Latitude 9450 2-in-1	17
Dimensions and weight	17
Processor	17
Chipset	18
Operating system	18
Memory	19
External ports and slots	19
Internal slots	20
Audio	20
Wireless module	20
WWAN module	21
Storage	21
Keyboard	22
Keyboard shortcuts of Latitude 9450 2-in-1	22
Camera	24
Clickpad	25
Power adapter	26
Power adapter requirements	26
Battery	27
Display	28
Fingerprint reader (optional)	29
Sensor	29
GPU—Integrated	30
Multiple display support matrix	30
Hardware security	30
Operating and storage environment	30
SafeShutter	31
ComfortView Plus	31
Dell support policy	31
Chapter 4: Working inside your computer	32
Safety instructions	32

Before working inside your computer.....	32
Safety precautions.....	33
Electrostatic discharge—ESD protection.....	33
ESD Field Service kit	34
Transporting sensitive components.....	35
After working inside your computer.....	35
BitLocker.....	35
Recommended tools.....	35
Screw list.....	36
Major components of Latitude 9450 2-in-1.....	37

Chapter 5: Removing and installing Customer Replaceable Units (CRUs)..... 39

Nano-SIM card tray.....	39
Removing the nano-SIM card tray	39
Installing the nano-SIM card tray	41
Base cover.....	42
Removing the base cover	42
Installing the base cover	44
Fan.....	46
Removing the right fan.....	46
Installing the right fan.....	46
Removing the left fan.....	47
Installing the left fan.....	48
Solid state drive.....	49
Removing the solid state drive.....	49
Installing the solid state drive.....	51
Wireless Wide Area Network (WWAN) card.....	51
Removing the WWAN card.....	51
Installing the WWAN card.....	54

Chapter 6: Removing and installing Field Replaceable Units (FRUs)..... 56

Battery.....	56
Rechargeable Li-ion battery precautions.....	56
Removing the battery	56
Installing the battery	59
Wireless Local Area Network (WLAN) antenna module.....	62
Removing the WLAN antenna module.....	62
Installing the WLAN antenna module.....	62
Heat sink.....	63
Removing the heat sink	63
Installing the heat sink.....	64
Speaker.....	65
Removing the left speaker.....	65
Installing the left speaker.....	66
Removing the right speaker	68
Installing the right speaker.....	69
Display assembly.....	70
Removing the display assembly.....	70
Installing the display assembly.....	72

System board.....	75
Removing the system board	75
Installing the system board	80
Power button with fingerprint-reader assembly.....	85
Removing the power button with fingerprint-reader assembly.....	85
Installing the power button with fingerprint-reader assembly	86
Palm-rest and keyboard assembly.....	87
Removing the palm-rest and keyboard assembly.....	87
Installing the palm-rest and keyboard assembly	88
Chapter 7: Software.....	90
Operating system.....	90
Drivers and downloads.....	90
Chapter 8: BIOS Setup.....	91
Entering BIOS Setup program.....	91
Navigation keys.....	91
F12 One Time Boot menu.....	91
View Advanced Setup options.....	92
View Service options.....	92
System Setup options.....	92
Updating the BIOS.....	112
Updating the BIOS in Windows.....	112
Updating the BIOS using the USB drive in Windows.....	113
Updating the BIOS from the One-Time boot menu.....	113
System and setup password.....	114
Assigning a System Setup password.....	114
Deleting or changing an existing system password or setup password.....	115
Clearing Chassis Intrusion Alert.....	115
Clearing CMOS settings.....	117
Clearing system and setup passwords.....	117
Chapter 9: Troubleshooting.....	118
Handling swollen rechargeable Li-ion batteries.....	118
Locating the Service Tag or Express Service Code of your Dell computer	118
Dell SupportAssist Pre-boot System Performance Check diagnostics.....	119
Running the SupportAssist Pre-Boot System Performance Check.....	119
Built-in self-test (BIST).....	119
M-BIST.....	119
Logical Built-in Self-test (L-BIST).....	120
LCD Built-in Self-Test (LCD-BIST).....	120
System-diagnostic lights.....	121
Recovering the operating system.....	122
Real-Time Clock (RTC Reset).....	123
Backup media and recovery options.....	123
Wi-Fi power cycle.....	123
Drain residual flea power (perform hard reset).....	123
Chapter 10: Getting help and contacting Dell.....	125

Views of Latitude 9450 2-in-1

Right



Figure 1. Right view

1. Universal audio port

Connect headphones or a headset (headphone and microphone combo).

2. Thunderbolt 4.0 with DisplayPort Alt Mode/USB Type-C/USB4/Power Delivery

Supports USB4, DisplayPort 2.1, Thunderbolt 4 and also enables you to connect to an external display using a display adapter. Provides data transfer rates of up to 40 Gbps for USB4 and Thunderbolt 4.

NOTE: You can connect a Dell Docking Station to the Thunderbolt 4 ports. For more information, search in the Knowledge Base Resource at [Dell Support site](#).

NOTE: A USB Type-C to DisplayPort adapter (sold separately) is required to connect a DisplayPort device.

NOTE: USB4 is backward compatible with USB 3.2, USB 2.0, and Thunderbolt 3.

NOTE: Thunderbolt 4 supports two 4K displays or one 8K display.

3. Wedge-shaped lock slot

Connect a security cable to prevent unauthorized movement of your computer.

Left



Figure 2. Left view

1. Thunderbolt 4.0 with DisplayPort Alt Mode/USB Type-C/USB4/Power Delivery

Supports USB4, DisplayPort 2.1, Thunderbolt 4 and also enables you to connect to an external display using a display adapter. Provides data transfer rates of up to 40 Gbps for USB4 and Thunderbolt 4.

NOTE: You can connect a Dell Docking Station to the Thunderbolt 4 ports. For more information, search in the Knowledge Base Resource at [Dell Support site](#).

NOTE: A USB Type-C to DisplayPort adapter (sold separately) is required to connect a DisplayPort device.

NOTE: USB4 is backward compatible with USB 3.2, USB 2.0, and Thunderbolt 3.

NOTE: Thunderbolt 4 supports two 4K displays or one 8K display.

2. Thunderbolt 4.0 with DisplayPort Alt Mode/USB Type-C/USB4/Power Delivery

Supports USB4, DisplayPort 2.1, Thunderbolt 4 and also enables you to connect to an external display using a display adapter. Provides data transfer rates of up to 40 Gbps for USB4 and Thunderbolt 4.

NOTE: You can connect a Dell Docking Station to the Thunderbolt 4 ports. For more information, search in the Knowledge Base Resource at [Dell Support site](#).

NOTE: A USB Type-C to DisplayPort adapter (sold separately) is required to connect a DisplayPort device.

NOTE: USB4 is backward compatible with USB 3.2, USB 2.0, and Thunderbolt 3.

NOTE: Thunderbolt 4 supports two 4K displays or one 8K display.

3. Battery-status light

Indicates the battery-charge status.

- If the computer is running on AC power, the battery-status light operates as follows:
 - Solid white—The battery is charging.
 - Off—The battery is fully charged.
- If the computer is running on battery, the battery-status light operates as follows:
 - Off—The battery is adequately charged.
 - Solid amber—The battery charge is critically low (approximately 30 minutes or less remaining battery life).

4. Nano-SIM card slot (optional)

Insert a nano-SIM card to connect to a mobile broadband network.

NOTE: Availability of the nano-SIM card slot depends on the region and configuration ordered.

Top

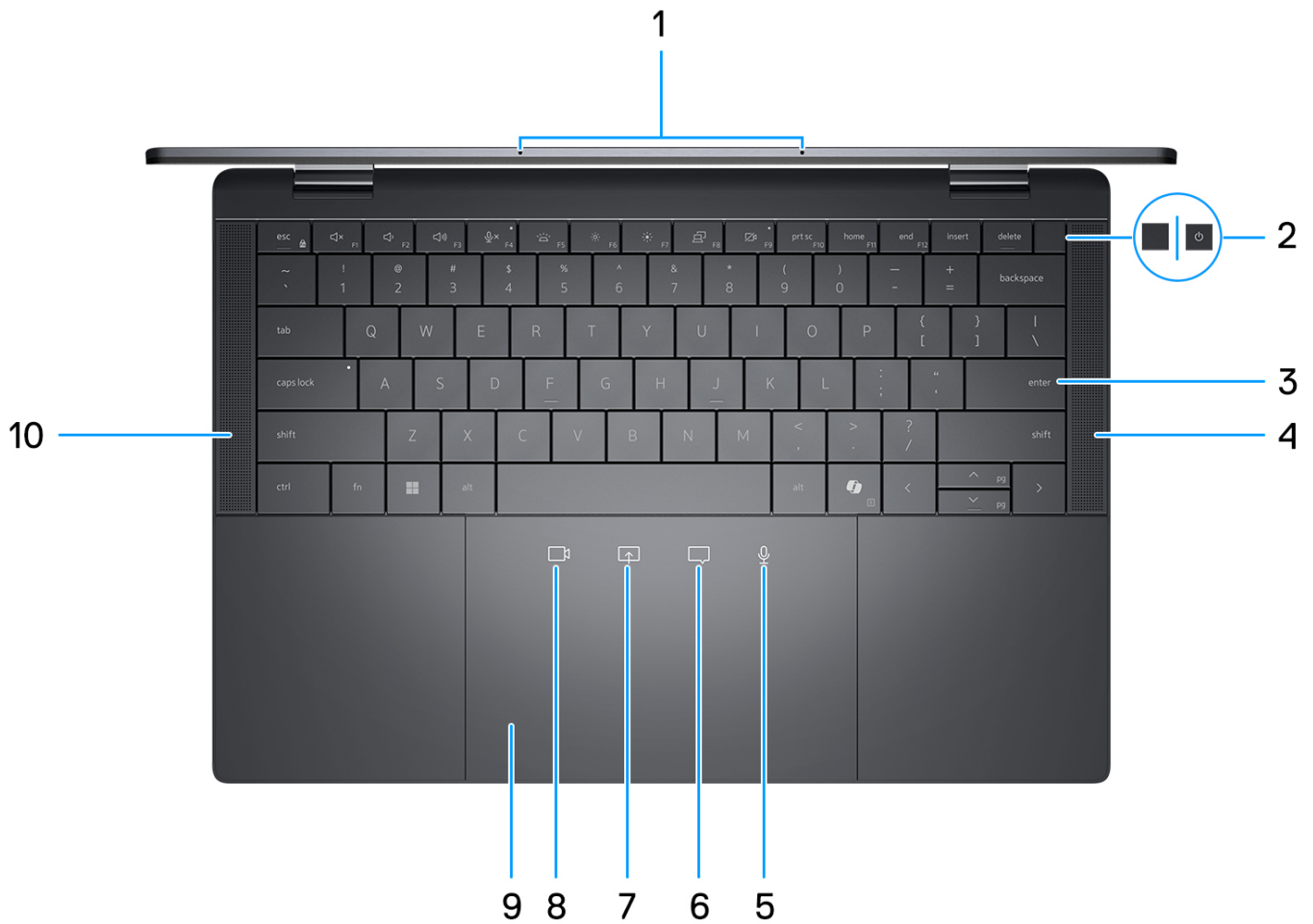

Figure 3. Top view

1. Microphones

Provides digital sound input for audio recording and voice calls.

2. Power button with optional fingerprint reader

Press to turn on the computer if it is turned off, in sleep state, or in hibernate state.

NOTE: When the computer is turned on, press the power button to put the computer into sleep state; press and hold the power button for 10 seconds to force shut-down the computer.

NOTE: The power-status light on the power button is available only on computers without the fingerprint reader. Computers that are shipped with the fingerprint reader that is integrated on the power button will not have the power-status light on the power button.

NOTE: You can customize the power-button behavior in Windows.

3. Zero-Lattice Keyboard with battery-saving backlight

Compact keyboard with larger keycaps and power-saving mini-LED backlight. Use the keyboard to input characters and perform functions.

4. Right speaker

Provides audio output.

5. Microphone control (Zoom app and Teams for work or school (Windows desktop) app support only)

Tap to mute or unmute the microphone. The microphone control indicates the status of the microphone as follows:

- Red – The microphone is muted.
- White – The microphone is unmuted.

6. Chat box control (Zoom app and Teams for work or school (Windows desktop) app support only)

Tap to show or hide the chat window. The control blinks when you receive a new chat message.

7. Screen share control (Zoom app and Teams for work or school (Windows desktop) app support only)

Tap to start or stop sharing your screen.

8. Webcam control (Zoom app and Teams for work or school (Windows desktop) app support only)

Tap to turn on or turn off the camera. The webcam control indicates the status of the camera as follows:

- Red – The camera is turned off.
- White – The camera is turned on.

9. Haptic Collaboration Touchpad

Move your finger on the touchpad to move the mouse pointer. Tap to left-click and tap two fingers to right-click. Collaboration icons are only visible when a Zoom or Teams call is ongoing. Compatible video conferencing applications are subject to change.

10. Left speaker

Provides audio output.

Front

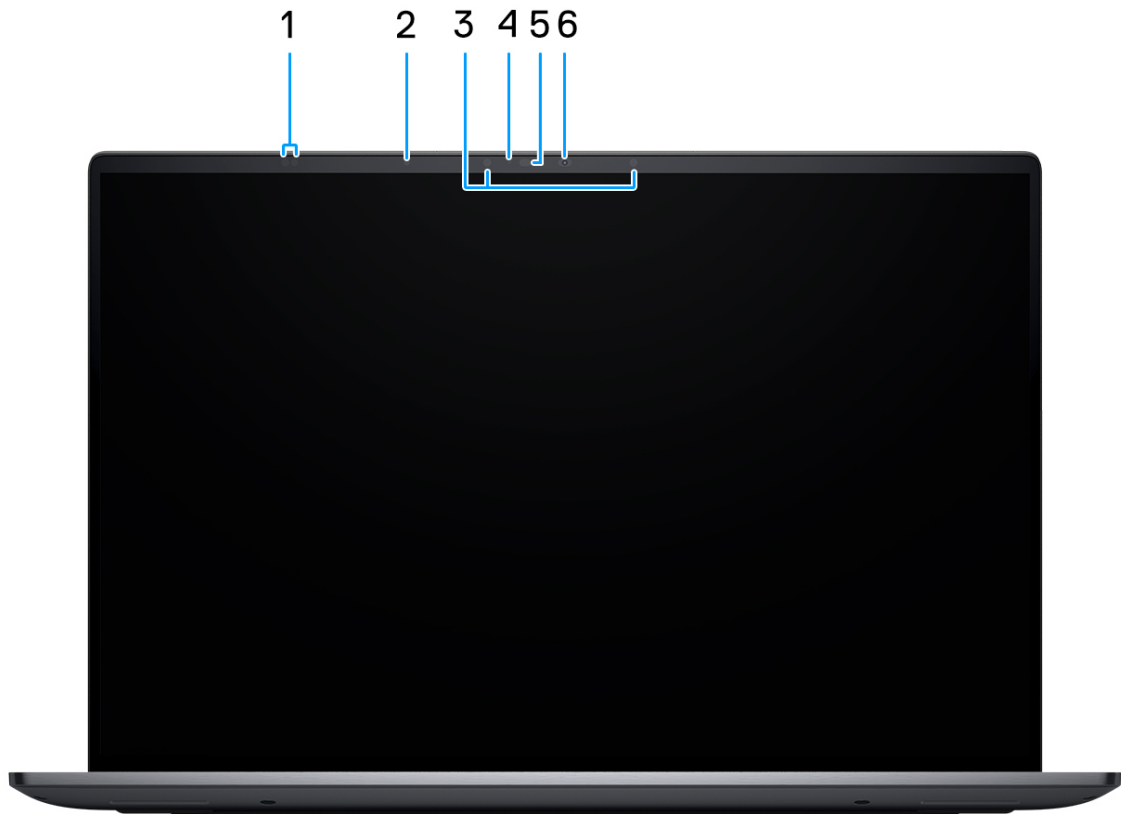

Figure 4. Front view

1. Time-of-Flight Sensors

Time-of-Flight or ToF sensor detects the absence of the user and locks the system for securing the computer and reducing power consumption.

2. Ambient-light sensor

The sensor detects the ambient light and automatically adjusts the display brightness.

3. Infrared emitters

Emits infrared light, which enables the infrared camera to sense and track motion.

4. Camera-status light

Turns on when the camera is in use.

5. Infrared camera

Enhances security when paired with Windows Hello face authentication.

6. RGB camera

Enables you to video chat, capture photos, and record videos.

Bottom



Figure 5. Bottom view

1. Speakers

Provide audio output.

2. Air vents

Air vents provide ventilation for your computer. Clogged air vents can cause overheating and can affect your computer's performance and potentially cause hardware issues. Keep the air vents clear of obstructions and clean them regularly to prevent the build-up of dust and dirt. For more information about cleaning air vents, search for articles in the Knowledge Base Resource at [Dell Support site](#).

3. Service tag label

The Service Tag is a unique alphanumeric identifier that enables Dell service technicians to identify the hardware components in your computer and access warranty information.

Service Tag

The service tag is a unique alphanumeric identifier that allows Dell service technicians to identify the hardware components in your computer and access warranty information.



Figure 6. Service tag location

Modes

The following modes are applicable for your Latitude 9450 2-in-1 computer.

Notebook



Figure 7. Notebook mode

Tablet



Figure 8. Tablet mode

Stand



Figure 9. Stand mode

Tent



Figure 10. Tent mode

Battery-charge status light

The following table lists the battery-charge status light of your Latitude 9450 2-in-1.

Table 1. Battery charge and status light behavior

Power source	LED behavior	System power state	Battery charge level
AC adapter	Off	S0 or S5	Fully charged
AC adapter	Solid white	S0 or S5	< Fully charged
Battery	Off	S0 or S5	11-100%
Battery	Solid amber (590+/-3 nm)	S0 or S5	< 10%

- S0 (ON): Computer is turned on.
- S4 (Hibernate): The computer consumes the least power in the Hibernate state than in the ON or OFF state. The computer is almost in the OFF state. The context data is written to a storage device, allowing you to resume from where you left when the computer is turned on.
- S5 (OFF): The computer is in a shutdown state.

Set up your Latitude 9450 2-in-1

About this task

NOTE: The images in this document may differ from your computer depending on the configuration you ordered.

Steps

1. Connect the power adapter and press the power button.



Figure 11. Connecting the power adapter

NOTE: The battery may go into power-saving mode during shipment to conserve charge on the battery. Ensure that the power adapter is connected to your computer when it is turned on for the first time.

2. Finish the operating system setup.

Follow the on-screen instructions to complete the setup. When setting up, Dell Technologies recommends that you:





- Connect to a network for Windows updates.

NOTE: If connecting to a secured wireless network, enter the password for the wireless network access when prompted.

- If connected to the Internet, sign in with or create a Microsoft account.
- On the **Support and Protection** screen, enter your contact details.

3. Locate and use Dell apps from the Windows Start menu—Recommended.

Table 2. Locate Dell apps in Windows

Resources	Description
	<p>Dell Command Update</p> <p>Updates your computer with critical fixes and latest device drivers as they become available. For more information about using Dell Command Update, see the product guides and third-party license documents at Dell Support site.</p>
	<p>Dell Digital Delivery</p> <p>Download software applications, which are purchased but not preinstalled on your computer. For more information about using Dell Digital Delivery, search in the Knowledge Base Resource at Dell Support site.</p>
	<p>SupportAssist</p> <p>SupportAssist proactively and predictively identifies hardware and software issues on your computer and automates the engagement process with Dell Technical support. It addresses performance and stabilization issues, prevents security threats, monitors, and detects hardware failures. For more information, see SupportAssist for Home PCs User's Guide.</p> <p> NOTE: In SupportAssist, click the warranty expiry date to renew or upgrade your warranty.</p>

Specifications of Latitude 9450 2-in-1

Dimensions and weight

The following table lists the height, width, depth, and weight of your Latitude 9450 2-in-1.

Table 3. Dimensions and weight

Description	Values
Height:	
Front height	14.92 mm (0.59 in.)
Rear height	16.28 mm (0.64 in.)
Width	310.50 mm (12.22 in.)
Depth	215.00 mm (8.46 in.)
Weight  NOTE: The weight of your computer depends on the configuration that is offered.	1.54 kg (3.38 lb)

Processor

The following table lists the details of the processors that are supported for your Latitude 9450 2-in-1.

Table 4. Processor



Description	Option one	Option two	Option three
Processor type	Intel Core Ultra 7 165U	Intel Core Ultra 5 135U	Intel Core Ultra 5 125U
Processor wattage	15 W	15 W	15 W
Processor total core count	10	10	10
Performance-cores	2	2	2
Efficient-cores	8	8	8
Processor total thread counts  NOTE: Intel Hyper-Threading Technology is only available on Performance-cores.	12	12	12
Processor speed	1.7 GHz to 4.9 GHz	1.6 GHz to 4.4 GHz	1.3 GHz to 4.3 GHz
Performance-cores frequency			
Processor base frequency	1.7 GHz	1.6 GHz	1.3 GHz

Table 4. Processor (continued)

Description		Option one	Option two	Option three
	Maximum turbo frequency	4.9 GHz	4.4 GHz	4.3 GHz
Efficient-cores frequency				
	Processor base frequency	1.2 GHz	1.1 GHz	0.8 GHz
	Maximum turbo frequency	3.4 GHz	3.2 GHz	3.2 GHz
Thermal Mode/Thermal Design Power (TDP)				
	Cool	12 W-20 W	12 W-20 W	12 W-20 W
	Optimized	15 W-35 W	15 W-35 W	15 W-35 W
	Quiet	12 W-20 W	12 W-20 W	12 W-20 W
	Ultra Performance	22 W-40 W	22 W-40 W	22 W-40 W
		 NOTE: Processor clock speeds and thermal design power differ according to the thermal mode selected in the My Dell app on your computer.		
	Processor cache	12 MB	12 MB	12 MB
	Integrated graphics	Intel Graphics	Intel Graphics	Intel Graphics

Chipset

The following table lists the details of the chipset that is supported in your Latitude 9450 2-in-1.

Table 5. Chipset

Description	Values
Chipset	Integrated with the processor
Processor	Intel Core Ultra 5/7
DRAM bus width	64-bit
Flash EPROM	64 MB
PCIe bus	Up to Gen4

Operating system

Your Latitude 9450 2-in-1 supports the following operating systems:

- Windows 11 22H2
- Windows 11 23H2

Memory

The following table lists the memory specifications of your Latitude 9450 2-in-1.

Table 6. Memory specifications

Description	Values
Memory slots	On-board memory  NOTE: The memory is integrated on the system board and is not upgradable.
Memory type	LPDDR5x
Memory speed	7467 MT/s
Maximum memory configuration	64 GB
Minimum memory configuration	16 GB
Memory configurations supported	<ul style="list-style-type: none"> • 16 GB, LPDDR5x, 7467 MT/s, dual-channel, integrated • 32 GB, LPDDR5x, 7467 MT/s, dual-channel, integrated • 64 GB, LPDDR5x, 7467 MT/s, dual-channel, integrated

External ports and slots

The following table lists the external ports and slots of your Latitude 9450 2-in-1.

Table 7. External ports and slots

Description	Values
Network port	Not supported
USB ports	Three Thunderbolt 4 with Power Delivery and DisplayPort (USB Type-C)  NOTE: You can connect a Dell Docking Station to any of the three ports. For more information, search in the Knowledge Base Resource at www.dell.com/support
Audio port	One universal audio port
Video port(s)	Supported through USB-C
Media-card reader	Not supported
Power-adaptor port	DC-in through one of the three Thunderbolt 4 USB Type-C ports
Security-cable slot	One wedge-shaped lock slot
SIM-card slot	nano-SIM slot (optional)

Internal slots

The following table lists the internal slots of your Latitude 9450 2-in-1.

Table 8. Internal slots

Description	Values
M.2	<ul style="list-style-type: none"> On-board Wi-Fi and Bluetooth One M.2 3052 slot for WWAN One M.2 2230 slot for solid state drive (SSD) <p>NOTE: To learn more about the features of different types of M.2 cards, search in the Knowledge Base Resource at Dell Support Site.</p>

Audio

The following table lists the audio specifications of your Latitude 9450 2-in-1.

Table 9. Audio specifications

Description	Values	
Audio controller	Waves MaxxAudio Pro 13 Output	
Stereo conversion	Supported	
Internal audio interface	SoundWire interface	
External audio interface	Universal audio jack	
Number of speakers	Four	
Internal-speaker amplifier	Realtek ALC1318	
External volume controls	Keyboard shortcut controls	
Speaker output:		
	Average	2 W
	Peak	2.5 W
Microphone	Dual-array microphone on FPC	

Wireless module

The following table lists the Wireless Local Area Network (WLAN) module that is supported on your Latitude 9450 2-in-1.

Table 10. Wireless module specifications

Description	Values
Model number	Intel BE200 NOTE: WLAN module is integrated on the system board and is not removable and/or ungradable.
Transfer rate	Up to 5760 Mbps

Table 10. Wireless module specifications (continued)

Description	Values
Frequency bands supported	2.4 GHz/5.0 GHz/6.0 GHz
Wireless standards	<ul style="list-style-type: none"> • WiFi 802.11a/b/g • Wi-Fi 4 (WiFi 802.11n) • Wi-Fi 5 (WiFi 802.11ac) • Wi-Fi 6E (802.11ax) or Wi-Fi 6 when Wi-Fi 6E is unavailable. • Wi-Fi 7 (WiFi 802.11be)
Encryption	<ul style="list-style-type: none"> • 64-bit/128-bit WEP • AES-CCMP • TKIP
Bluetooth wireless card	Bluetooth version 5.4

WWAN module

The following table lists the Wireless Wide Area Network (WWAN) module that is supported on your Latitude 9450 2-in-1.



 **NOTE:** The WWAN module is available only on certain configurations and may not be available in your region.

Table 11. WWAN module specifications

Description	Values
Model number	Qualcomm Snapdragon X62 Global 5G Modem (DW5932e)
Transfer rate	<ul style="list-style-type: none"> • 5G NR: DL 3.5 Gbps/UL 900 Mbps • LTE: DL 1.6 Gbps (CAT19)/UL 211 Mbps (CAT18) • UMTS: DL DC-HSPA+ Rel8:42 Mbps/UL 5.76 Mbps
Frequency bands supported	<ul style="list-style-type: none"> • NR (n1, n2, n3, n5, n7, n8, n12, n13, n14, 18, n20, n25, n26, n28, n30, n38, n40, n41, n48, n53, n66, n70, n71, n75, n76, n77, n78, n79) • LTE (B1, B2, B3, B4, B5, B7, B8, B12, B13, B14, B17, B18, B19, B20, B25, B26, B28, B29, B30, B32, B34, B38, B39, B40, B41, B42, B43, B46, B48, B66, B71) • WCDMA/HSPA+ (1, 2, 4, 5, 8)
Wireless standards	<ul style="list-style-type: none"> • NR FR1 (Sub6) FDD/TDD • LTE FDD/TDD • WCDMA/HSPA+ • GPS/GLONASS/Beidou/Galileo
Encryption	Supported
Global Navigation Satellite System (GNSS)	L1 GNSS Frequency
<p> NOTE: For instructions on how to find your computer's IMEI (International Mobile Station Equipment Identity) number, search in the Knowledge Base Resource at Dell Support site.</p>	

Storage

This section lists the storage options on your Latitude 9450 2-in-1.

Your computer supports one of the following solid state drives

Table 12. Storage specifications

Storage type	Interface type	Capacity
M.2 2230, Class 35 solid state drive	Gen 4 PCIe x4 NVMe	256 GB/512 GB/1 TB
M.2 2230, Class 35 solid state drive, self-encrypting drive	Gen 4 PCIe x4 NVMe	512 GB
M.2 2230, Class 25 solid state drive	Gen 4 PCIe x4 NVMe	2 TB

Keyboard

The following table lists the keyboard specifications of your Latitude 9450 2-in-1.

Table 13. Keyboard specifications

Description	Values
Keyboard type	Single-pointing spill-resistant, zero-lattice keyboard with battery-saving backlight
Keyboard layout	QWERTY
Number of keys	<ul style="list-style-type: none"> • United States and Canada: 79 keys • United Kingdom: 80 keys • Japan: 83 keys
Keyboard size	X=19.05 mm key pitch Y=18.05 mm key pitch
Keyboard shortcuts	<p>Some keys on your keyboard have two symbols on them. These keys can be used to type alternate characters or to perform secondary functions. To type the alternate character, press Shift and the desired key. To perform secondary functions, press Fn and the desired key.</p> <p>NOTE: You can define the primary behavior of the function keys (F1–F12) changing Function Key Behavior in the BIOS setup program.</p> <p>NOTE: If Copilot in Windows is not available on your computer, pressing the Copilot key launches Windows search. For more information about Copilot in Windows, search in the Knowledge Base Resource at the Dell Support site.</p>

Keyboard shortcuts of Latitude 9450 2-in-1

NOTE: Keyboard characters may differ depending on the keyboard language configuration. Keys that are used for shortcuts remain the same across all language configurations.

Some keys on your keyboard have two symbols on them. These keys can be used to type alternate characters or to perform secondary functions. The symbol that is shown on the lower part of the key refers to the character that is typed out when the key is pressed. If you press shift and the key, the symbol that is shown on the upper part of the key is typed out. For example, if you press **2**, **2** is typed out; if you press **Shift + 2**, **@** is typed out.

The keys F1-F12 at the top row of the keyboard are function keys for multimedia control, as indicated by the icon at the bottom of the key. Press the function key to invoke the task represented by the icon. For example, pressing F1 mutes the audio (see the following table).

However, if the function keys F1-F12 are needed for specific software applications, multimedia functionality can be disabled by pressing **Fn + Esc**. Later, multimedia control can be invoked by pressing **Fn** and the respective function key. For example, mute audio by pressing **Fn + F1**.

NOTE: You can also define the primary behavior of the function keys (F1–F12) by changing **Function Key Behavior** in BIOS setup program.

Table 14. List of keyboard shortcuts

Keys	Primary behavior
Copilot	Launch Copilot in Windows NOTE: If Copilot in Windows is not available on your computer, the Copilot key launches Windows Search. For more information about Copilot in Windows, search in the Knowledge Base Resource at Dell Support site .
F1	Mute audio
F2	Decrease volume
F3	Increase volume
F4	Mute mic
F5	Adjust keyboard backlight level NOTE: Press to cycle the keyboard backlight level through low, medium, or high.
F6	Decrease display brightness
F7	Increase display brightness
F8	Switch to external display
F9	SafeShutter control
F10	Print screen
F11	Home
F12	End

The **Fn** key is also used with select keys on the keyboard to invoke secondary functions.

Table 15. Secondary behavior

Key combination for the task	Secondary behavior
Fn + F1	Operating system and application-specific F1 behavior
Fn + F2	Operating system and application-specific F2 behavior
Fn + F3	Operating system and application-specific F3 behavior
Fn + F4	Operating system and application-specific F4 behavior
Fn + F5	Operating system and application-specific F5 behavior
Fn + F6	Operating system and application-specific F6 behavior
Fn + F8	Operating system and application-specific F8 behavior
Fn + F9	Operating system and application-specific F9 behavior
Fn + F10	Operating system and application-specific F10 behavior
Fn + F11	Operating system and application-specific F11 behavior
Fn + F12	Operating system and application-specific F12 behavior
Fn + PrtScr	Turn off or on wireless

Table 15. Secondary behavior (continued)

Key combination for the task	Secondary behavior
Fn + B	Pause or break
Fn + Insert	Sleep
Fn + S	Toggle scroll lock
Fn + R	System request
Fn + Ctrl	Open the application menu
Fn + Esc	Toggle Fn-key lock
Fn + PgUp	Page up
Fn + PgDn	Page down
Fn + Home	Home
Fn + End	End

Camera

The following table lists the camera specifications of your Latitude 9450 2-in-1.

Table 16. Camera specifications

Description	Values
Number of cameras	One
Camera type	<ul style="list-style-type: none"> FHD RGB + IR Camera with built-in collaboration features Low light capability TNR, Intelligent Privacy, IPU6, Proximity Sensor, Intel Camera Sensing Technology (ExpressSign-in 2.0), dual-array microphones
Camera location	Front camera
Camera sensor type	Intel Camera Sensing Technology (ExpressSign-in 2.0)
Camera resolution:	
Still image	2.07 megapixels
Video	1920 x 1080 (FHD) at 60 fps
Infrared camera resolution:	
Still image	0.18 megapixels
Video	1280 x 720 at 30 fps
Diagonal viewing angle:	
Camera	82.2 degrees
Infrared camera	78.1 degrees



Clickpad

The following table lists the clickpad specifications of your Latitude 9450 2-in-1.

Table 17. Clickpad specifications

Description	Values
Clickpad type	Haptic Collaboration Touchpad
Haptic functionality	Control the level of sound and haptic feedback from the Windows 11 operating system settings, Bluetooth and Devices . Select from 0 % to 100 % for intensity of the haptic feedback.
Collaboration controls on clickpad	<p>Four controls are available to control video, share screen, chat, and microphone functions during conference calls.</p> <p>NOTE:</p> <ul style="list-style-type: none"> The collaboration controls are compatible only with Zoom and Microsoft Teams for work or school. The collaboration controls are visible only when a conference call is ongoing.
Collaboration controls settings	<ul style="list-style-type: none"> Customize settings for the brightness of the controls to adjust to the ambient light. Customize settings to activate collaboration controls with a single tap or a double tap. Customize settings to enable or disable specific controls.
Collaboration controls functionality	<ul style="list-style-type: none"> Webcam control: Turn on or off the camera. <ul style="list-style-type: none"> White icon: The camera is turned on. Red icon: The camera is turned off. Screen share control: Tap once to share your screen. Tap again to stop sharing. Chat box control: Show or hide the chat window. The control blinks when you receive a new chat message. Microphone control: Turn on or mute the microphone. <ul style="list-style-type: none"> White icon: The microphone is turned on. Red icon: The microphone is muted.
Applications required to enable collaboration controls	<ul style="list-style-type: none"> Dell Optimizer version 4.2.0.0 and higher Zoom Client version 5.9.3 and higher Microsoft Teams for work or school (Windows desktop) version 1.6.00.24078 and higher
Clickpad resolution:	> 300 dpi
Clickpad dimensions:	
Horizontal	135.00 mm (5.31 in.)
Vertical	91.40 mm (3.59 in.)
Clickpad gestures	For more information about clickpad gestures available on Windows, see the Microsoft Knowledge Base article at support.microsoft.com .
<p>NOTE: To use the collaboration touchpad (CTP) controls feature on your keyboard, ensure that you have the latest versions of the Dell Optimizer app and Zoom or Teams for work or school installed on your computer. Dell Optimizer supports modular installation which allows you to select the modules you want to install. Install the collaboration touchpad module within the Dell Optimizer app to use the functionality of collaboration controls. For more information, search for the Dell Optimizer User's Guide in the Knowledge Base Resource at Dell Support site.</p>	

Table 17. Clickpad specifications (continued)

Description	Values
 NOTE: For more information about how to configure and use the collaboration controls, search for the Collaboration Touchpad Reference Guide in the Knowledge Base Resource at Dell Support site . Or, watch the Collaboration Touchpad Use and Configuration video.	
 NOTE: Collaboration Touchpad is supported only on Teams for work or school (Windows desktop) application. Teams for home and Teams on web are currently not supported.	

Power adapter

The following table lists the power adapter specifications of your Latitude 9450 2-in-1.

Table 18. Power adapter specifications

Description	Option one	Option two	Option three
Type	60 W AC adapter, USB-C	65 W AC adapter, USB-C	100 W AC adapter, USB-C
Power-adapter dimensions:			
Height	22.00 mm (0.866 in.)	28.00 mm (1.10 in.)	26.50 mm (1.04 in.)
Width	66.00 mm (2.598 in.)	51.00 mm (2.01 in.)	60.00 mm (2.36 in.)
Depth	55.00 mm (2.165 in.)	112.00 mm (4.41 in.)	122.00 mm (4.80 in.)
Weight	0.105 kg (0.231 lbs)	0.201 kg (0.443 lbs)	0.33 kg (0.731 lbs)
Input voltage	100 VAC – 240 VAC	100 VAC – 240 VAC	100 VAC – 240 VAC
Input frequency	50 Hz – 60 Hz	50 Hz – 60 Hz	50 Hz – 60 Hz
Input current (maximum)	1.70 A	1.70 A	1.70 A
Output current (continuous)	<ul style="list-style-type: none"> ● 5 V/3 A ● 9 V/3 A ● 15 V/3 A ● 20 V/3 A 	<ul style="list-style-type: none"> ● 5 V/3 A ● 9 V/3 A ● 15 V/3 A ● 20 V/3.25 A 	<ul style="list-style-type: none"> ● 5 V/3 A ● 9 V/3 A ● 15 V/3 A ● 20 V/5 A
Rated output voltage	<ul style="list-style-type: none"> ● 5 VDC ● 9 VDC ● 15 VDC ● 20 VDC 	<ul style="list-style-type: none"> ● 5 VDC ● 9 VDC ● 15 VDC ● 20 VDC 	<ul style="list-style-type: none"> ● 5 VDC ● 9 VDC ● 15 VDC ● 20 VDC
Temperature range:			
Operating	0°C to 40°C (32°F to 104°F)	0°C to 40°C (32°F to 104°F)	0°C to 40°C (32°F to 104°F)
Storage	-20°C to 70°C (-4°F to 158°F)	-40°C to 70°C (-40°F to 158°F)	-40°C to 70°C (-40°F to 158°F)
 CAUTION: Operating and storage temperature ranges may differ among components, so operating or storing the device outside these ranges may impact the performance of specific components.			

Power adapter requirements

This section contains the power adapter requirements for Latitude 9450 2-in-1.

 **NOTE:** If you did not purchase the Dell-branded power adapter that is recommended for your computer, ensure that the power adapter you use meets the following requirements:

Table 19. Power adapter requirements for Latitude 9450 2-in-1

Description	Value
Power that is required from a power adapter to achieve optimal performance.	65 W
Power that is required to charge the computer at a slower speed. <i>i</i> NOTE: A warning message may appear informing you about the use of a lower-powered adapter and slower charging speed.	Less than 60 W
Minimum power that is required from a power adapter to operate the computer and charge the battery. <i>i</i> NOTE: A warning message appears informing you about the use of a lower-powered adapter and slower charging speed.	27 W
USB Power Delivery (PD) fast charging	Supported
ExpressCharge mode	Supported <i>i</i> NOTE: Ensure that the computer is connected to a 100 W power adapter for this feature to be supported. <i>i</i> NOTE: ExpressCharge mode must also be enabled in the BIOS Setup screen by selecting Power > Battery Configuration > ExpressCharge , then press Enter .



Battery

The following table lists the battery specifications of your Latitude 9450 2-in-1.

Table 20. Battery specifications

Description	Values
Battery type	3-cell, 60 WHr, ExpressCharge Boost capable, Long-lifecycle capable
Battery voltage	11.55 VDC
Battery weight (maximum)	0.24 kg (0.52 lb)
Battery dimensions:	
Height	250.70 mm (9.87 in.)
Width	81.18 mm (3.19 in.)
Depth	5.35 mm (0.21 in.)
Temperature range:	
Operating	<ul style="list-style-type: none"> Charge: 0°C to 50°C (32°F to 122°F) Discharge: 0°C to 70°C (32°F to 158°F)
Storage	-20°C to 60°C (-4°F to 140°F)
Battery operating time	Varies depending on operating conditions and can significantly reduce under certain power-intensive conditions.
Battery charging time (approximate)	<ul style="list-style-type: none"> 3 hours (when the computer is turned off)

Table 20. Battery specifications (continued)

Description	Values
 NOTE: You can control the charging time, duration, start and end time, and so on, using the Dell Power Manager application. For more information about Dell Power Manager, search in the Knowledge Base Resource at Dell Support Site .	<ul style="list-style-type: none"> 80% in 60 min with ExpressCharge 1.0 35% in 20 min with ExpressCharge Boost
Coin-cell battery	Not supported
 CAUTION: Operating and storage temperature ranges may differ among components, so operating or storing the device outside these ranges may impact the performance of specific components.	
 CAUTION: Dell Technologies recommends that you charge the battery regularly for optimal power consumption.	

Display

The following table lists the display specifications of your Latitude 9450 2-in-1.

Table 21. Display specifications

Description	Values
Display type	14-inch, Quad High Definition (QHD+)
Touch options	Yes
Display-panel technology	IPS
Display-panel dimensions (active area):	
Height	188.49 mm (7.42 in.)
Width	301.59 mm (11.87 in.)
Diagonal	355.64 mm (14.00 in.)
Display-panel native resolution	2560 x 1600
Luminance (typical)	500 nits
Megapixels	2.30
Color gamut	sRGB 100%
Pixels Per Inch (PPI)	161
Contrast ratio (minimum)	1000:1
Response time (maximum)	35 ms
Refresh rate	60 Hz
Horizontal view angle	88 degree
Vertical view angle	88 degree

Table 21. Display specifications (continued)

Description	Values
Pixel pitch	0.15 mm
Power consumption (maximum)	2.85 W
Anti-glare vs glossy finish	anti-reflection, anti-smudge

Fingerprint reader (optional)

The following table lists the specifications of the optional fingerprint-reader of your Latitude 9450 2-in-1.

Table 22. Fingerprint reader specifications

Description	Values
Sensor technology	Trans-capacitive sensing
Sensor resolution	500 dpi
Sensor pixel size	108 mm x 88 mm

Sensor

The following table lists the sensor of your Latitude 9450 2-in-1.

Table 23. Sensor

Sensor support
Low Power Vision AI Based User Presence Detection
Ambient Light Sensor
Windows Auto Brightness
IR User Proximity Detection
eCompass/Magnetometer
Accelerometer
Gyro + Accelerometer
Adaptive Thermal Performance (through Gyroscope/Accelerometer)
Screen Rotation support
Near Field Proximity Sensor
Hall Effect Sensor
Sensor Hub
Wake/Power on with lid open
Dell ExpressSign-In 1.0 (through Proximity Sensor)
Dell ExpressSign-in 2.0 (through Intel Camera Sensing Technology)
GPS (through WWAN Card only)
Gyroscope
Accelerometer: ST Micro LIS2DW12TR (1st) or Bosch BMA422 (2nd) in the base (system board) for 2-in-1

Table 23. Sensor (continued)

Sensor support
Accelerometer + Gyro: ST Micro LSM6DSOISTR in the hinge-up sensor board for 2-in-1

GPU—Integrated

The following table lists the specifications of the integrated Graphics Processing Unit (GPU) supported by your Latitude 9450 2-in-1.

Table 24. GPU—Integrated

Controller	Memory size	Processor
Intel Graphics	Shared system memory	Intel Core Ultra 5/7

Multiple display support matrix

The following table lists the multiple display support matrix of your Latitude 9450 2-in-1.

Table 25. Multiple display support matrix

Graphics Card	Supported external displays with computer internal display on	Supported external displays with computer internal display off
Integrated GPU	Up to 3	Up to 4

Hardware security

The following table lists the hardware security of your Latitude 9450 2-in-1.

Table 26. Hardware security

Hardware security
Trusted Platform Module (TPM) 2.0 FIPS-140-2 Certified/TCG Certified
Touch Fingerprint Reader (in Power Button) with Control Vault 3.0 Plus Advanced Authentication with FIPS 140-2 Level 3 Certification (Optional)
Face IR camera (Windows Hello compliant) with ExpressSign-in 1.0 (Proximity Sensor) and ExpressSign-in 2.0 (Camera Sensing)
Dell SafeBIOS - Verifies the integrity of BIOS using a secure off-host source, and if the test fails, captures and stores a copy of the test result in a secure area in the computer.
Dell SafeBIOS - Alerts when malicious activity is detected
Dell SafeID - Dedicated FIPS Level 3 security chip secures end user credentials ¹ - TCG Certified
Dell SafeSupply Chain - Optional tamper evident packing and pre-imaging HDD wipes to NIST standards from a secure Dell facility.
Dell SafeShutter - Control your camera shutter by pressing F9 on your keyboard to enable or disable the shutter.

Operating and storage environment

This table lists the operating and storage specifications of your Latitude 9450 2-in-1.

Airborne contaminant level: G1 as defined by ISA-S71.04-1985

Table 27. Computer environment

Description	Operating	Storage
Temperature range	0°C to 35°C (32°F to 95°F)	-40°C to 65°C (-40°F to 140°F)
Relative humidity (maximum)	10% to 90% (non-condensing)	0% to 95% (non-condensing)
Vibration (maximum)*	0.66 GRMS	Not applicable
Shock (maximum)	140 G†	Not applicable
Altitude range	0 m to 3,048 m (0 ft to 10,000 ft)	0 m to 10,668 m (0 ft to 35,000 ft)
 CAUTION: Operating and storage temperature ranges may differ among components, so operating or storing the device outside these ranges may impact the performance of specific components.		

* Measured using a random vibration spectrum that simulates the user environment.

† Measured using a 2 ms half-sine pulse.

SafeShutter

This section details the SafeShutter specifications of your Latitude 9450 2-in-1.

SafeShutter lets you take control of your privacy with the camera disable (F9 key), and mic mute (F4 key) to override software settings. When the camera is on, press the F9 key to close the camera shutter and then press the F9 key again to open the camera shutter.

ComfortView Plus

 **WARNING: Prolonged exposure to blue light from the display may lead to long-term effects such as eye strain, eye fatigue, or damage to the eyes.**

Blue light is a color in the light spectrum which has a short wavelength and high energy. Chronic exposure to blue light, particularly from digital sources may disrupt sleep patterns and cause long-term effects such as eye strain, eye fatigue, or damage to the eyes.

The display on this computer is designed to minimize blue light and complies with TÜV Rheinland's requirement for low blue light displays.

Low blue light mode is enabled at the factory, so no further configuration is necessary.

To reduce the risk of eye strain, it is also recommended that you:

- Position the display at a comfortable viewing distance between 20 and 28 inches (50 cm and 70 cm) from your eyes.
- Blink frequently to moisten your eyes, wet your eyes with water, or apply suitable eye drops.
- Take an extended break for 20 minutes every two hours.
- Look away from your display, and gaze at a distant object at 20 ft (609.60 cm) away for at least 20 seconds during each break.









Dell support policy

For information about Dell support policy, search in the Knowledge Base Resource at [Dell Support Site](#).

Working inside your computer



Safety instructions

Use the following safety guidelines to protect your computer from potential damage and to ensure your personal safety. Unless otherwise noted, each procedure in this document assumes that you have read the safety information that shipped with your computer.

-  **WARNING:** Before working inside your computer, read the safety information that is shipped with your computer. For more safety best practices, see [Dell Regulatory Compliance Home Page](#).
-  **WARNING:** Disconnect your computer from all power sources before opening the computer cover or panels. After you finish working inside the computer, replace all covers, panels, and screws before connecting your computer to an electrical outlet.
-  **CAUTION:** To avoid damaging the computer, ensure that the work surface is flat, dry, and clean.
-  **CAUTION:** You should only perform troubleshooting and repairs as authorized or directed by the Dell technical support team. Damage due to servicing that is not authorized by Dell is not covered by your warranty. See the safety instructions that is shipped with the product or at [Dell Regulatory Compliance Home Page](#).
-  **CAUTION:** Before touching anything inside your computer, ground yourself by touching an unpainted metal surface, such as the metal at the back of the computer. While you work, periodically touch an unpainted metal surface to dissipate static electricity which could harm internal components.
-  **CAUTION:** To avoid damaging the components and cards, handle them by their edges, and avoid touching the pins and the contacts.
-  **CAUTION:** When you disconnect a cable, pull it by its connector or its pull tab, not the cable itself. Some cables have connectors with locking tabs or thumbscrews that you must disengage before disconnecting the cable. When disconnecting cables, keep them evenly aligned to avoid bending the connector pins. When connecting cables, ensure that the connector on the cable is correctly oriented and aligned with the port.
-  **CAUTION:** Press and eject any installed card from the media-card reader.
-  **CAUTION:** Exercise caution when handling rechargeable Li-ion batteries in laptops. Swollen batteries should not be used and should be replaced and disposed properly.

Before working inside your computer

Steps

1. Save and close all open files and exit all open applications.
2. Shut down your computer. For Windows operating system, click **Start** >  **Power** > **Shut down**.
 -  **NOTE:** If you are using a different operating system, see the documentation of your operating system for instructions.
3. Turn off all the attached peripherals.
4. Disconnect your computer from the electrical outlets.
5. Disconnect all attached network devices and peripherals, such as keyboard, mouse, and monitor from your computer.
6. Remove any media card and optical drive from your computer, if applicable.
7. Enter the Service Mode.

Service Mode

Service Mode is used to cut off power without disconnecting the battery cable from the system board before conducting repairs in the computer.

 **CAUTION:** If you are unable to turn on the computer to put it into Service Mode, proceed to disconnect the battery cable. To disconnect the battery cable, follow the steps in [Removing the battery](#).

 **NOTE:** Ensure that your computer is shut down and the power adapter is disconnected.

- a. Press and hold the B key and the power button for 3 seconds or until the Dell logo appears on the screen.
- b. Press any key to continue.
- c. If the power adapter is not disconnected, a message prompting you to disconnect the power adapter appears on the screen. Disconnect the power adapter and then press any key to enter into the Service Mode. The Service Mode process automatically skips the following step if the **Owner Tag** of the computer is not set up in advance by the user.
- d. When the **ready-to-proceed** message appears on the screen, press any key to proceed. The computer emits three short beeps and shuts down immediately.
The computer shuts down and enters the Service Mode.

Safety precautions

The safety precautions chapter details the primary steps to be taken before performing any disassembly instructions.

Observe the following safety precautions before you perform any installation or break or fix procedures involving disassembly or reassembly:

- Turn off the computer and all attached peripherals.
- Disconnect the computer and all attached peripherals from AC power.
- Disconnect all network cables, telephone, and telecommunications lines from the computer.
- Use an ESD field service kit when working inside any notebook to avoid electrostatic discharge (ESD) damage.
- After removing any computer component, carefully place the removed component on an anti-static mat.
- Wear shoes with non-conductive rubber soles to reduce the chance of getting electrocuted.

Standby power

Dell products with standby power must be unplugged before you open the case. Systems that incorporate standby power are powered while turned off. The internal power enables the computer to be remotely turned on (Wake-on-LAN) and suspended into a sleep mode and has other advanced power management features.

Unplugging, pressing, and holding the power button for 15 seconds should discharge residual power in the system board.

Bonding

Bonding is a method for connecting two or more grounding conductors to the same electrical potential. This is done by using a field service electrostatic discharge (ESD) kit. When connecting a bonding wire, ensure that it is connected to bare metal and never to a painted or nonmetal surface. The wrist strap should be secure and in full contact with your skin, and ensure that you remove all jewelry such as watches, bracelets, or rings prior to bonding yourself and the equipment.

Electrostatic discharge—ESD protection

ESD is a major concern when you handle electronic components, especially sensitive components such as expansion cards, processors, memory modules, and system boards. A slight charge can damage circuits in ways that may not be obvious, such as intermittent problems or a shortened product life span. As the industry pushes for lower power requirements and increased density, ESD protection is an increasing concern.

Two recognized types of ESD damage are catastrophic and intermittent failures.

- **Catastrophic** – Catastrophic failures represent approximately 20 percent of ESD-related failures. The damage causes an immediate and complete loss of device functionality. An example of catastrophic failure is a memory module that has received a static shock and immediately generates a "No POST/No Video" symptom with a beep code that is emitted for missing or nonfunctional memory.

- **Intermittent** – Intermittent failures represent approximately 80 percent of ESD-related failures. The high rate of intermittent failures means that most of the time when damage occurs, it is not immediately recognizable. The memory module receives a static shock, but the tracing is merely weakened and does not immediately produce outward symptoms that are related to the damage. The weakened trace may take weeks or months to melt, and in the meantime may cause degradation of memory integrity, intermittent memory errors, and so on.

Intermittent failures that are also called latent or "walking wounded" are difficult to detect and troubleshoot.

Perform the following steps to prevent ESD damage:

- Use a wired ESD wrist strap that is properly grounded. Wireless anti-static straps do not provide adequate protection. Touching the chassis before handling parts does not ensure adequate ESD protection on parts with increased sensitivity to ESD damage.
- Handle all static-sensitive components in a static-safe area. If possible, use anti-static floor pads and workbench pads.
- When unpacking a static-sensitive component from its shipping carton, do not remove the component from the anti-static packing material until you are ready to install the component. Before unwrapping the anti-static packaging, use the anti-static wrist strap to discharge the static electricity from your body. For more information about the wrist strap and ESD wrist strap tester, see [Components of an ESD Field Service Kit](#).
- Before transporting a static-sensitive component, place it in an anti-static container or packaging.

ESD Field Service kit

The unmonitored field service kit is the most commonly used service kit. Each Field Service kit includes three main components: anti-static mat, wrist strap, and bonding wire.

 **CAUTION: It is critical to keep ESD-sensitive devices away from internal parts that are insulated and often highly charged, such as plastic heat sink casings.**

Working Environment

Before deploying the ESD Field Service kit, assess the situation at the customer location. For example, deploying the kit for a server environment is different than for a desktop or laptop environment. Servers are typically installed in a rack within a data center; desktops or laptops are typically placed on office desks or cubicles. Always look for a large open flat work area that is free of clutter and large enough to deploy the ESD kit with additional space to accommodate the type of computer that is being repaired. The workspace should also be free of insulators that can cause an ESD event. On the work area, insulators such as styrofoam and other plastics should always be moved at least 12 inches or 30 centimeters away from sensitive parts before physically handling any hardware components.

ESD Packaging

All ESD-sensitive devices must be shipped and received in static-safe packaging. Metal, static-shielded bags are preferred. However, you should always return the damaged component using the same ESD bag and packaging that the new part arrived in. The ESD bag should be folded over and taped shut and all the same foam packing material should be used in the original box that the new part arrived in. ESD-sensitive devices should be removed from packaging only at an ESD-protected work surface, and parts should never be placed on top of the ESD bag because only the inside of the bag is shielded. Always place parts in your hand, on the anti-static mat, in the computer, or inside an ESD bag.

Components of an ESD Field Service kit

The components of an ESD Field Service kit are:

- **Anti-Static Mat** – The anti-static mat is dissipative and parts can be placed on it during service procedures. When using an anti-static mat, your wrist strap should be snug and the bonding wire should be connected to the anti-static mat and to any bare metal on the computer being worked on. Once deployed properly, service parts can be removed from the ESD bag and placed directly on the anti-static mat. ESD-sensitive items are safe in your hand, on the anti-static mat, in the computer, or inside an ESD bag.
- **Wrist Strap and Bonding Wire** – The wrist strap and bonding wire can be either directly connected between your wrist and bare metal on the hardware if the anti-static mat is not required, or connect to the anti-static mat to protect hardware that is temporarily placed on the mat. The physical connection of the wrist strap and bonding wire between your skin, the anti-static mat, and the hardware is known as bonding. Use only Field Service kits with a wrist strap, anti-static mat, and bonding wire. Never use wireless wrist straps. Always be cautious that the internal wires of a wrist strap are prone to

damage from normal wear and tear, and must be checked regularly with a wrist strap tester in order to avoid accidental ESD hardware damage. It is recommended to test the wrist strap and bonding wire at least once per week.

- **ESD Wrist Strap Tester** – The wires inside an ESD strap are prone to damage over time. When using an unmonitored kit, it is a best practice to regularly test the strap prior to each service, and at a minimum, test once per week. A wrist strap tester is the best method for doing this test. To perform the test, plug the bonding-wire of the wrist-strap into the tester while it is strapped to your wrist and push the button to test. A green LED is lit if the test is successful; a red LED is lit and an alarm sounds if the test fails.

 **NOTE:** It is recommended to always use the traditional wired ESD grounding wrist strap and protective anti-static mat when servicing Dell products. In addition, it is critical to keep sensitive parts separate from all insulator parts while servicing the computer.

Transporting sensitive components

When transporting ESD sensitive components such as replacement parts or parts to be returned to Dell, it is critical to place these parts in anti-static bags for safe transport.

After working inside your computer

About this task

 **CAUTION:** Leaving stray or loose screws inside your computer may severely damage your computer.

Steps

1. Replace all screws and ensure that no stray screws remain inside your computer.
2. Connect any external devices, peripherals, or cables you removed before working on your computer.
3. Replace any media cards, disks, or any other parts that you removed before working on your computer.
4. Connect your computer to their electrical outlets.

 **NOTE:** To exit service mode, ensure to connect the AC adapter to the power-adapter port on your computer.

5. Press the power button to turn on the computer.

BitLocker

 **CAUTION:** If BitLocker is not suspended before updating the BIOS, the BitLocker key is not recognized the next time you reboot the computer. You will then be prompted to enter the recovery key to progress, and the system displays a prompt for the recovery key on each reboot. If the recovery key is not known, this can result in data loss or an operating system reinstall. For more information, see Knowledge Article: [updating the BIOS on Dell systems with BitLocker enabled](#).

The installation of the following components triggers BitLocker:

- Hard disk drive or solid-state drive
- System board

Recommended tools

The procedures in this document may require the following tools:

- Phillips screwdriver #0
- Phillips screwdriver #1
- Plastic scribe

Screw list

- NOTE:** When removing screws from a component, it is recommended to note the screw type and the quantity of screws, and then place them in a screw storage box. This is to ensure that the correct number of screws and correct screw type is restored when the component is replaced.
- NOTE:** Some computers have magnetic surfaces. Ensure that the screws are not left attached to such surfaces when replacing a component.
- NOTE:** Screw color may vary depending on the configuration ordered.

Table 28. Screw list









Component	Screw type	Quantity	Image
Base cover	Captive screws	6	
Solid state drive	Captive screw	1	
WWAN-card bracket	M1.6x2.3	1	
Right fan	M1.6x3	2	
Left fan	M1.6x3	2	
Display cable/Left Type-C bracket	M1.6x3	2	
Right Type-C bracket	M1.6x3	3	
Display assembly	M2.5x4	6	
	M1.6x3	2	
Heat sink	Captive screws	3	
Battery	M2x3	6	
	Captive screws	2	
Right speaker	M1.6x1.8	2	
WLAN antenna module	M1.6x2	2	
Power button with fingerprint reader assembly	M1.6x2	1	

Table 28. Screw list (continued)

Component	Screw type	Quantity	Image
System board	M1.6x2	7	
	M1.6x3	6	

Major components of Latitude 9450 2-in-1

The following image shows the major components of Latitude 9450 2-in-1.

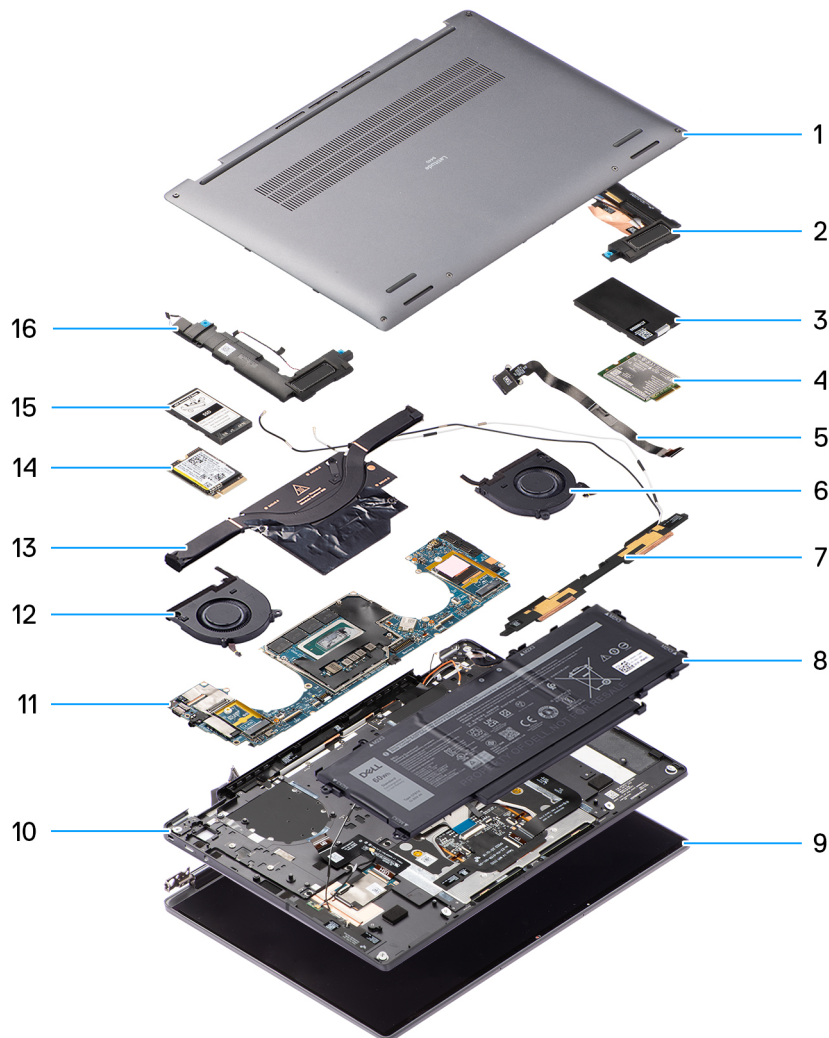



Figure 12. Explode view

1. Base cover
2. Speaker
3. WWAN card shielding cover
4. WWAN card
5. Power button
6. Fan

7. WLAN antenna module
8. Battery
9. Display assembly
10. Palm-rest and keyboard assembly
11. System board
12. Fan
13. Heatsink
14. Solid state drive
15. Solid state drive shielding cover
16. Speaker

 **NOTE:** Dell provides a list of components and their part numbers for the original system configuration purchased. These parts are available according to warranty coverage that you have purchased. Contact your Dell sales representative for purchase options.

Removing and installing Customer Replaceable Units (CRUs)

The replaceable components in this chapter are Customer Replaceable Units (CRUs).

 **CAUTION:** Customers can replace only the Customer Replaceable Units (CRUs) following the safety precautions and replacement procedures.

 **NOTE:** The images in this document may differ from your computer depending on the configuration you ordered.

Nano-SIM card tray

Removing the nano-SIM card tray

Prerequisites

1. Follow the procedure in [Before working inside your computer](#).

About this task

The following image provides a visual representation of the nano-SIM card tray removal procedure.

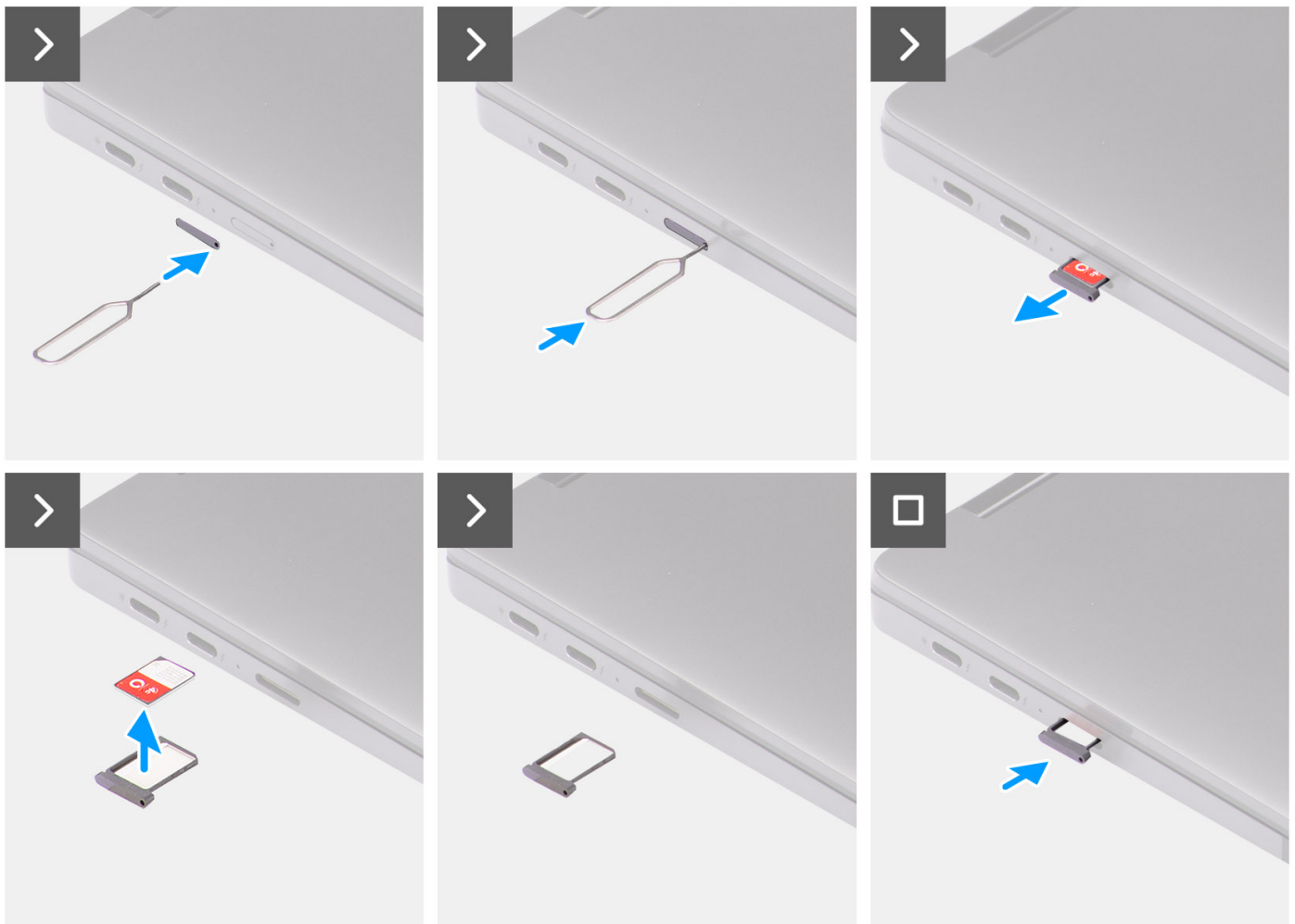

Figure 13. Removing the nano-SIM card tray

Steps

1. Insert the nano-SIM card removal pin into the release hole to release the nano-SIM card tray.
2. Push the pin to disengage the lock, and eject the nano-SIM card tray.
3. Slide the nano-SIM card tray out of the slot on the system.
4. Remove the nano-SIM from the nano-SIM card tray.
5. Slide the nano-SIM card tray back into the slot on the system.

Installing the nano-SIM card tray

Prerequisites

If you are replacing a component, remove the existing component before the installation procedure.

About this task

The following image provides a visual representation of the nano-SIM card tray installation procedure.

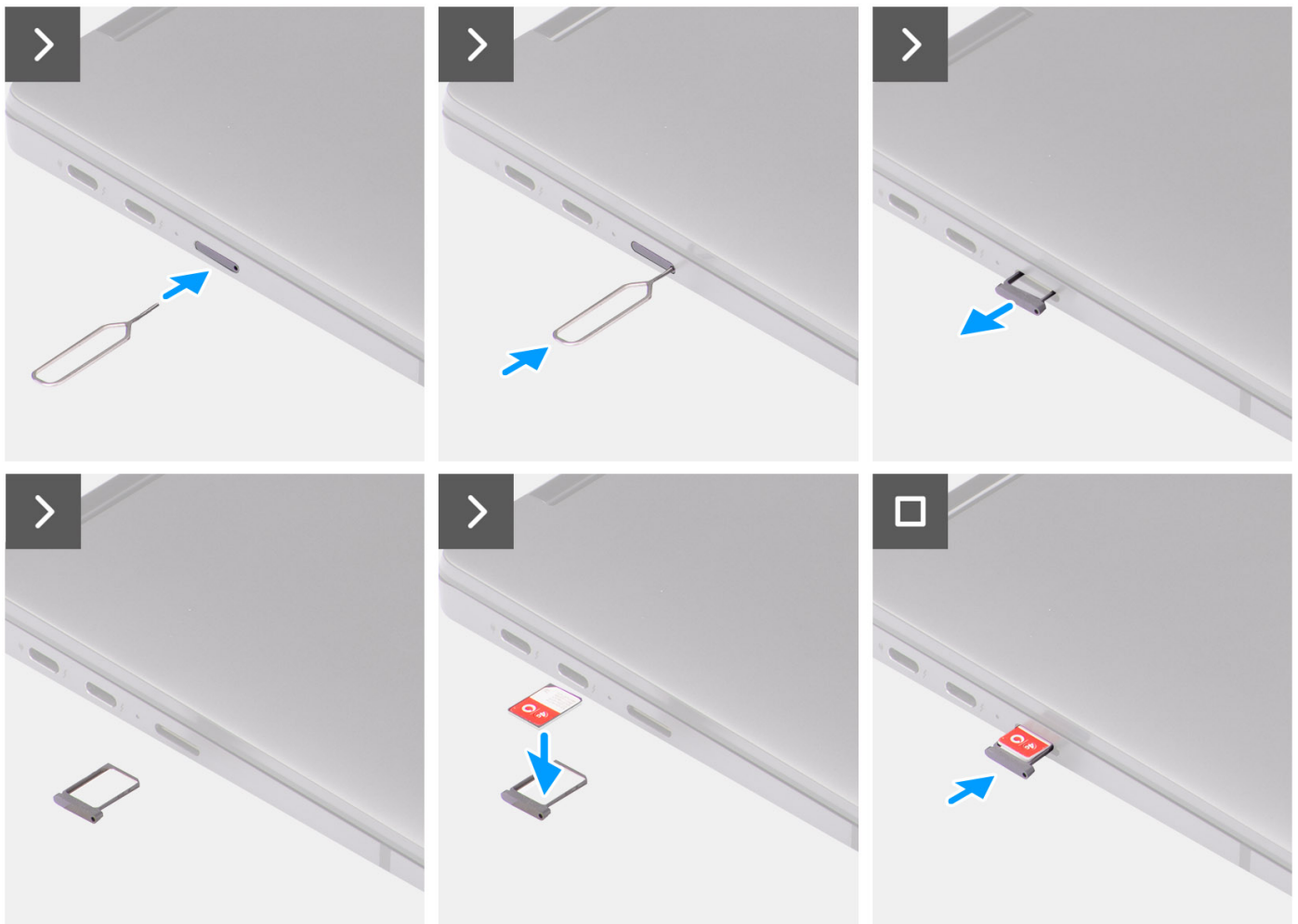

Figure 14. Installing the nano-SIM card tray

Steps

1. Insert the nano-SIM card removal pin into the release hole to remove the nano-SIM card tray.
2. Push the pin to disengage the lock, and eject the nano-SIM card tray.

3. Slide the nano-SIM card tray out of the slot on the system.
4. Align and place the nano-SIM card in the dedicated slot on the nano-SIM card tray.
5. Slide the nano-SIM card tray back into the slot on the system.

Next steps

Follow the procedure in [after working inside your computer](#).

Base cover

Removing the base cover

Prerequisites

1. Follow the procedure in [Before working inside your computer](#).
2. Remove the [nano SIM-card tray](#), if applicable.

About this task

The following images indicate the location of the base cover and provide a visual representation of the removal procedure.



Figure 15. Base cover removal

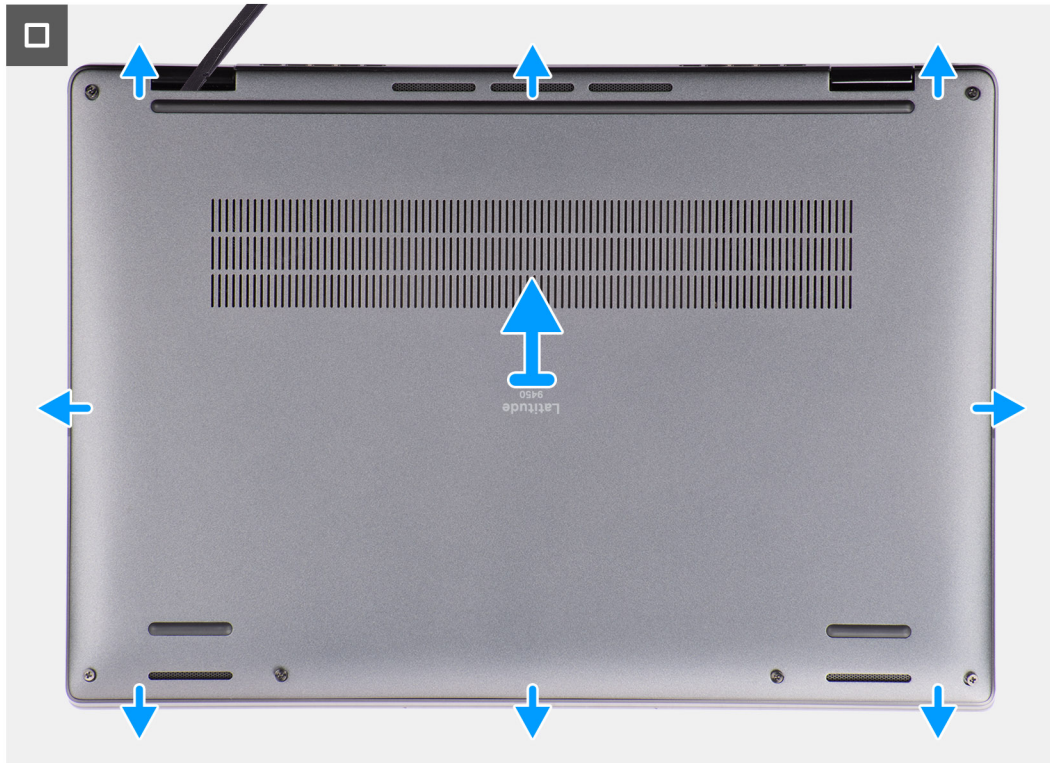

Figure 16. Base cover removal

Steps

1. Loosen the six captive screws that secure the base cover to the computer.
2. Using a plastic scribe, pry open the base cover starting from the recesses, which are in the U-shaped indents at the top edge of the base cover, near the hinges.



Figure 17. Base cover pry points

CAUTION: Do not lift the base cover from the top side immediately after prying it from the recesses, as this will damage the base cover. Proceed with the following steps to loosen all the hooks that secure the base cover to the computer before removing the base cover.

3. Pry open the top side of the base cover and continue working on the left, right and, bottom sides to open the base cover.
4. Hold the left and right sides of the base cover, and remove the base cover from the computer.
NOTE: Ensure that your computer is in Service Mode. If your computer is unable to enter Service Mode, disconnect the battery cable from the system board. To disconnect the battery cable, follow step 5 to step 7.
5. Disconnect the battery cable from the system board.
6. Peel the tape that secures the battery cable to the battery.
7. Press and hold the power button for five seconds to ground the computer and drain the flea power.

Installing the base cover

Prerequisites

If you are replacing a component, remove the existing component before performing the installation procedure.

About this task

The following images indicate the location of the base cover and provide a visual representation of the installation procedure.

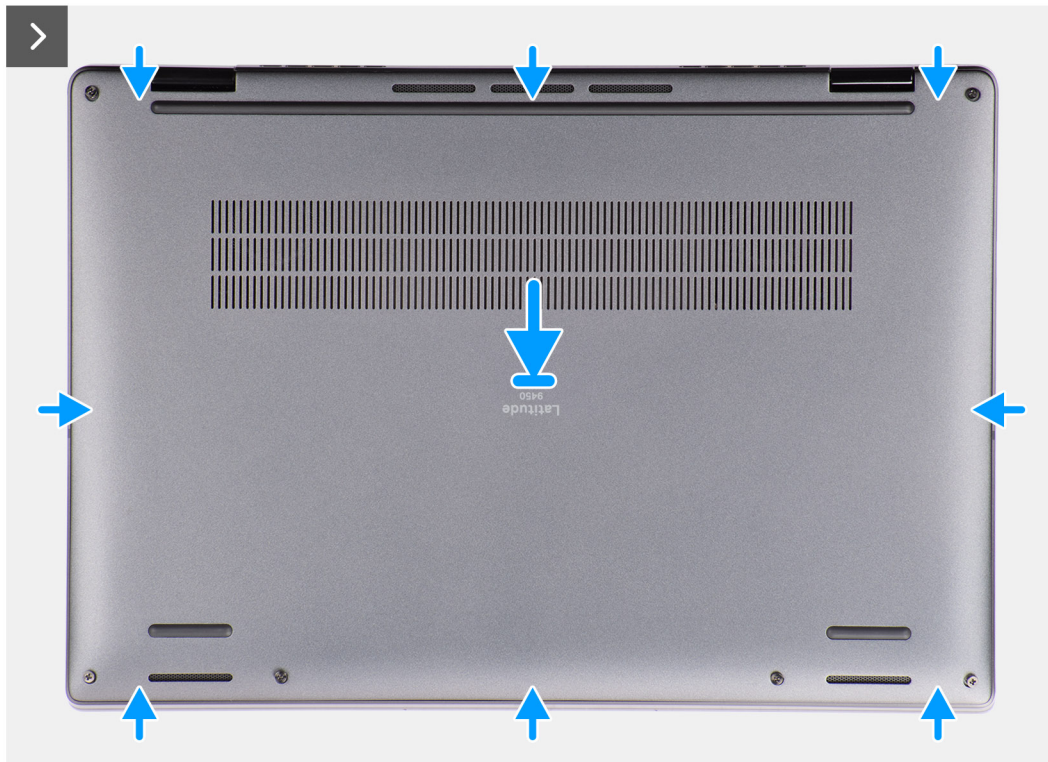

Figure 18. Installing the base cover



Figure 19. Installing the base cover

NOTE: If the battery is not a pre-requisite and if you have disconnected the battery cable, ensure to connect the battery cable. To connect the battery cable, follow step 1 and step 2 in the procedure.

Steps

1. Connect the battery cable to the system board.
2. Adhere the tape that secures the battery cable to the battery.
3. Align and place the base cover on the palm-rest and keyboard assembly, and snap the base cover into place.
4. Tighten the six captive screws to secure the base cover to the computer.

Next steps

1. Install the [nano SIM-card tray](#), if applicable.
2. Follow the procedure in [after working inside your computer](#).

Fan

Removing the right fan

Prerequisites

1. Follow the procedure in [Before working inside your computer](#).
2. Remove the [nano-SIM card tray](#), if applicable.
3. Remove the [base cover](#).

About this task

The following image indicates the location of the right fan and provides a visual representation of the removal procedure.

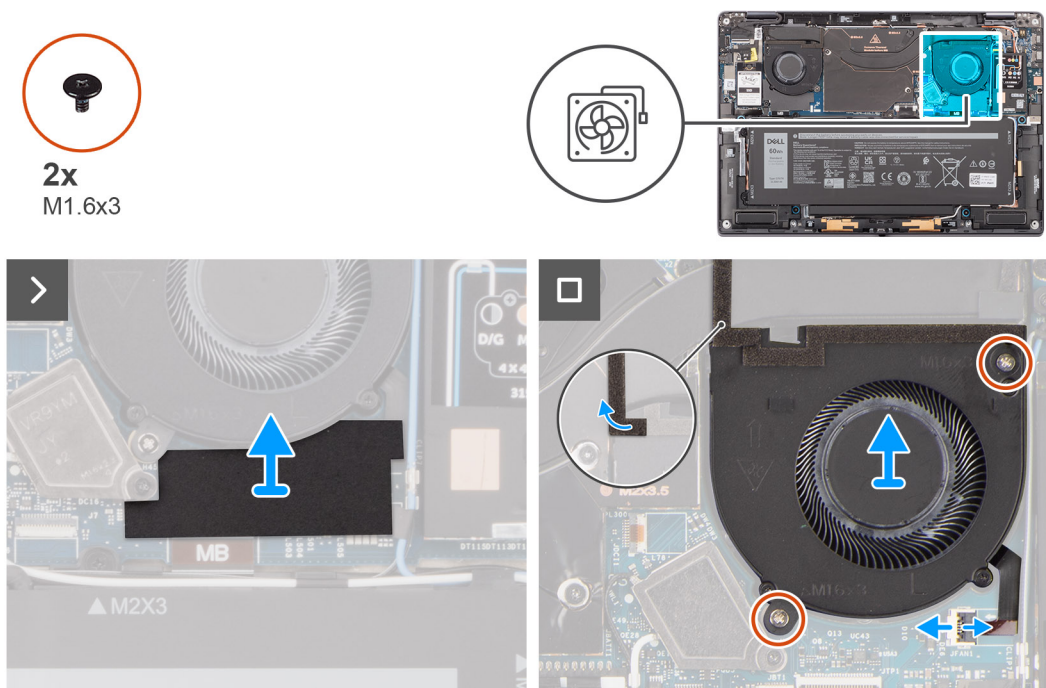



Figure 20. Removing the right fan

Steps

1. Peel off the mylar sticker from the system board.
2. Disconnect the right-fan FPC cable from the connector (FANR) on the system board.
3.  **CAUTION: Ensure to lift the piece of foam extension from the heat sink to prevent it from getting in between components.**

Remove the two (M1.6x3) screws that secure the right fan to the palm-rest and keyboard assembly.

4. Lift the right fan off the palm-rest and keyboard assembly.

Installing the right fan

Prerequisites

If you are replacing a component, remove the existing component before performing the installation procedure.

About this task

The following image indicates the location of the right fan and provides a visual representation of the installation procedure.

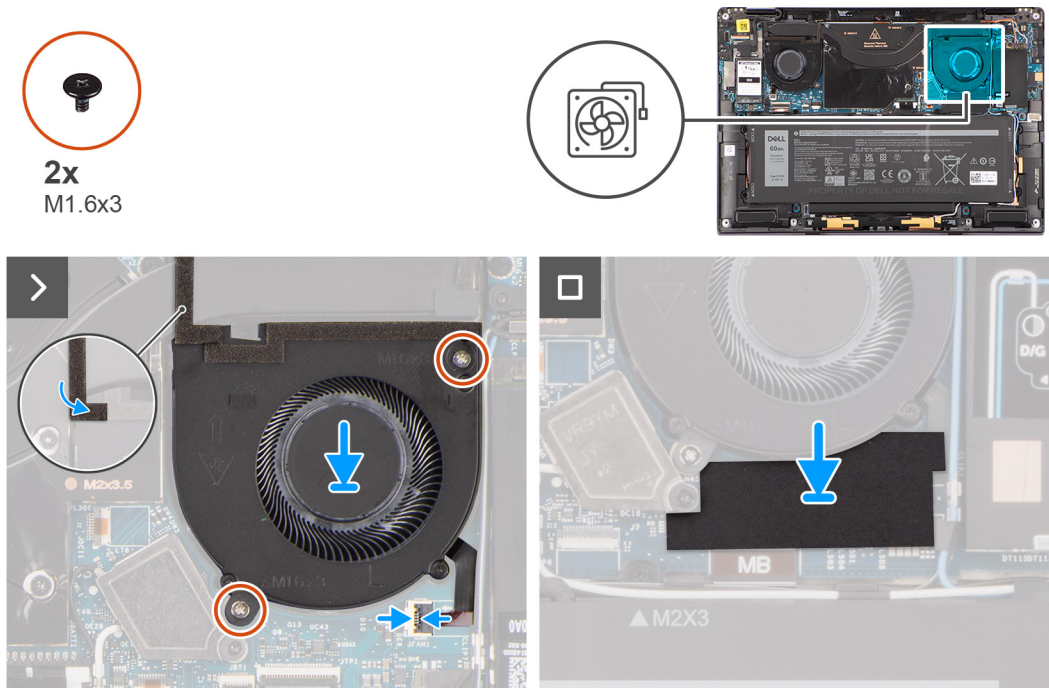

Figure 21. Installing the right fan

Steps

1. Align and place the right fan onto the palm-rest and keyboard assembly.
CAUTION: Ensure to replace the piece of foam extension on top of the right fan to prevent it from getting in between components.
2. Replace the two (M1.6x3) screws to secure the right fan to the palm-rest and keyboard assembly.
3. Connect the right-fan FPC cable to the connector (FANR) on the system board.
4. Adhere the mylar sticker on the system board.

Next steps

1. Install the [base cover](#).
2. Install the [nano-SIM card tray](#), if applicable.
3. Follow the procedure in [after working inside your computer](#).

Removing the left fan

Prerequisites

1. Follow the procedure in [Before working inside your computer](#).
2. Remove the [nano-SIM card tray](#), if applicable.
3. Remove the [base cover](#).

About this task

The following image indicates the location of the left fan and provides a visual representation of the removal procedure.

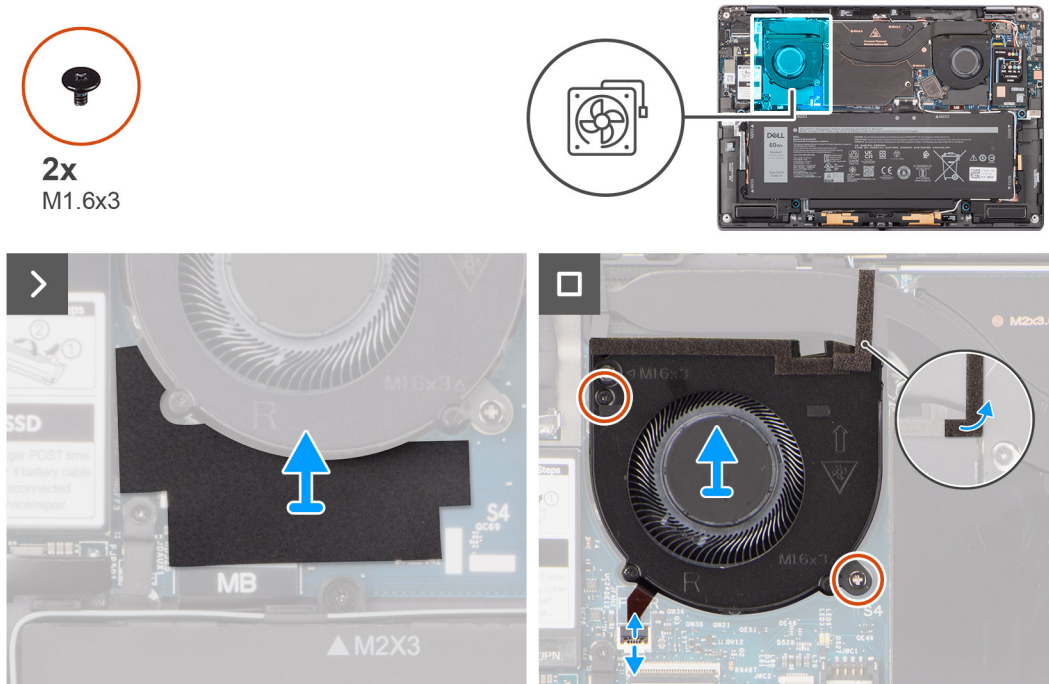

Figure 22. Removing the left fan

Steps

1. Peel off the mylar sticker from the system board.
2. Disconnect the left-fan FPC cable from the connector (FANL) on the system board.
3. **CAUTION:** Ensure to lift the piece of foam extension from the heat sink to prevent it from getting in between components.

Remove the two (M1.6x3) screws that secure the left fan to the palm-rest and keyboard assembly.

4. Lift the left fan off the palm-rest and keyboard assembly.

Installing the left fan

Prerequisites

If you are replacing a component, remove the existing component before performing the installation procedure.

About this task

The following image indicates the location of the left fan and provides a visual representation of the installation procedure.

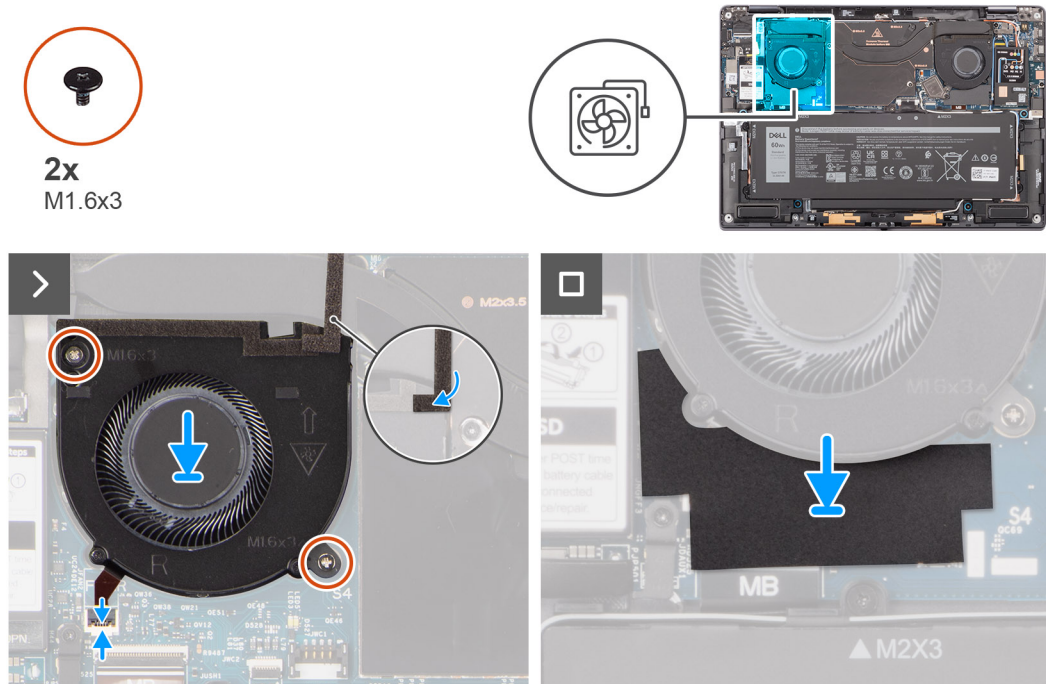

Figure 23. Installing the left fan

Steps

1. Align and place the left fan onto the palm-rest and keyboard assembly.
 - NOTE:** Ensure to replace the piece of foam extension on top of the left fan to prevent it from getting in between components.
2. Replace the two (M1.6x3) screws to secure the left fan to the palm-rest and keyboard assembly.
3. Connect the left-fan FPC cable to the connector (FANL) on the system board.
4. Adhere the mylar sticker on the system board.

Next steps

1. Install the [base cover](#).
2. Install the [nano-SIM card tray](#), if applicable.
3. Follow the procedure in [after working inside your computer](#).

Solid state drive

Removing the solid state drive

Prerequisites

1. Follow the procedure in [before working inside your computer](#).
2. Remove the [nano-SIM card tray](#), if applicable.
3. Remove the [base cover](#).

About this task

The following images indicate the location of the solid state drive and provide a visual representation of the removal procedure.

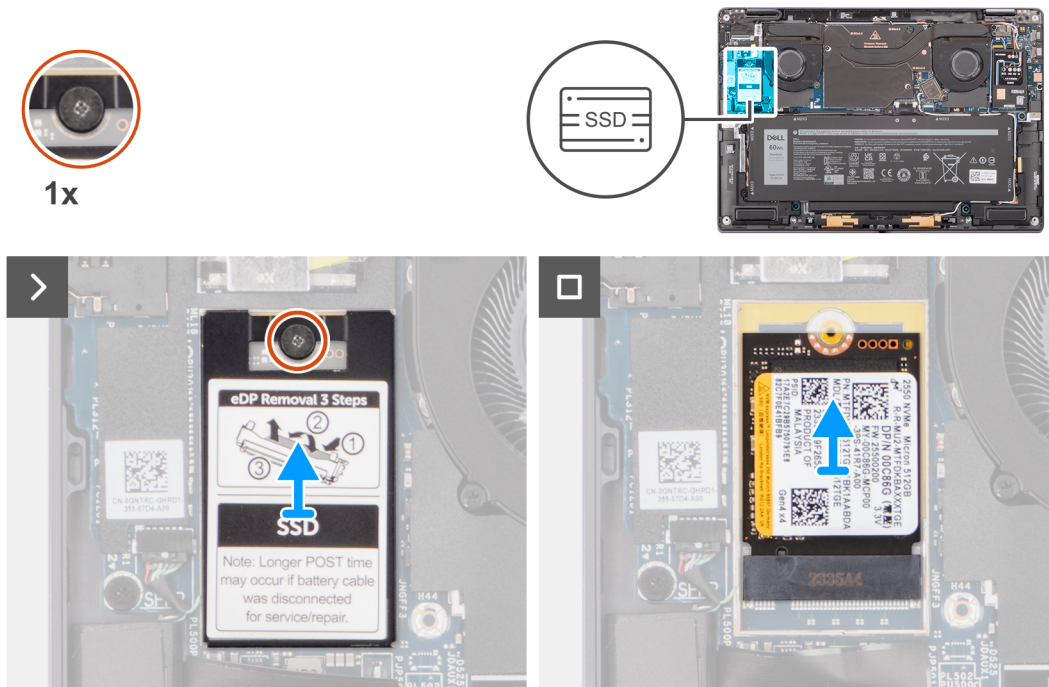

Figure 24. Removing the solid state drive

Steps

1. Loosen the captive screw that secures the solid state drive shielding cover to the system board.
2. Pry open the solid state drive shielding cover from the recesses that are at its left or right sides.



Figure 25. Solid state drive shielding cover

3. Slide and remove the solid state drive from the solid state drive slot on the system board.

Installing the solid state drive

Prerequisites

If you are replacing a component, remove the existing component before performing the installation procedure.

About this task

The following image indicates the location of the solid state drive and provides a visual representation of the installation procedure.

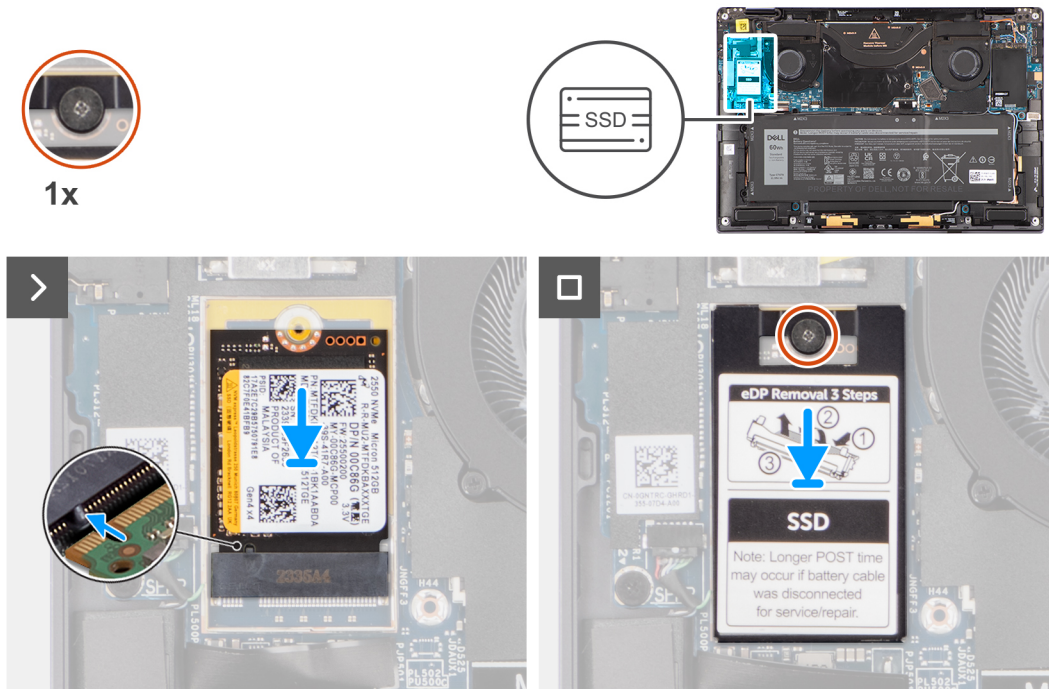

Figure 26. Installing the solid state drive

Steps

1. Align the notch on the solid state drive with the tab on the solid state drive slot.
2. Slide the solid state drive at an angle into the solid state drive slot on the system board.
3. Align and place the solid state drive shielding cover, press to fit it firmly in place to cover the solid state drive.
4. Tighten the captive screw to secure the solid state drive to the system board.

Next steps

1. Install the [base cover](#).
2. Install the [nano-SIM card tray](#), if applicable.
3. Follow the procedure in [after working inside your computer](#).

Wireless Wide Area Network (WWAN) card

Removing the WWAN card

Prerequisites

1. Follow the procedure in [before working inside your computer](#).
2. Remove the [nano-SIM card tray](#), if applicable.
3. Remove the [base cover](#).

About this task

The following images indicate the location of the WWAN card and provide a visual representation of the removal procedure.

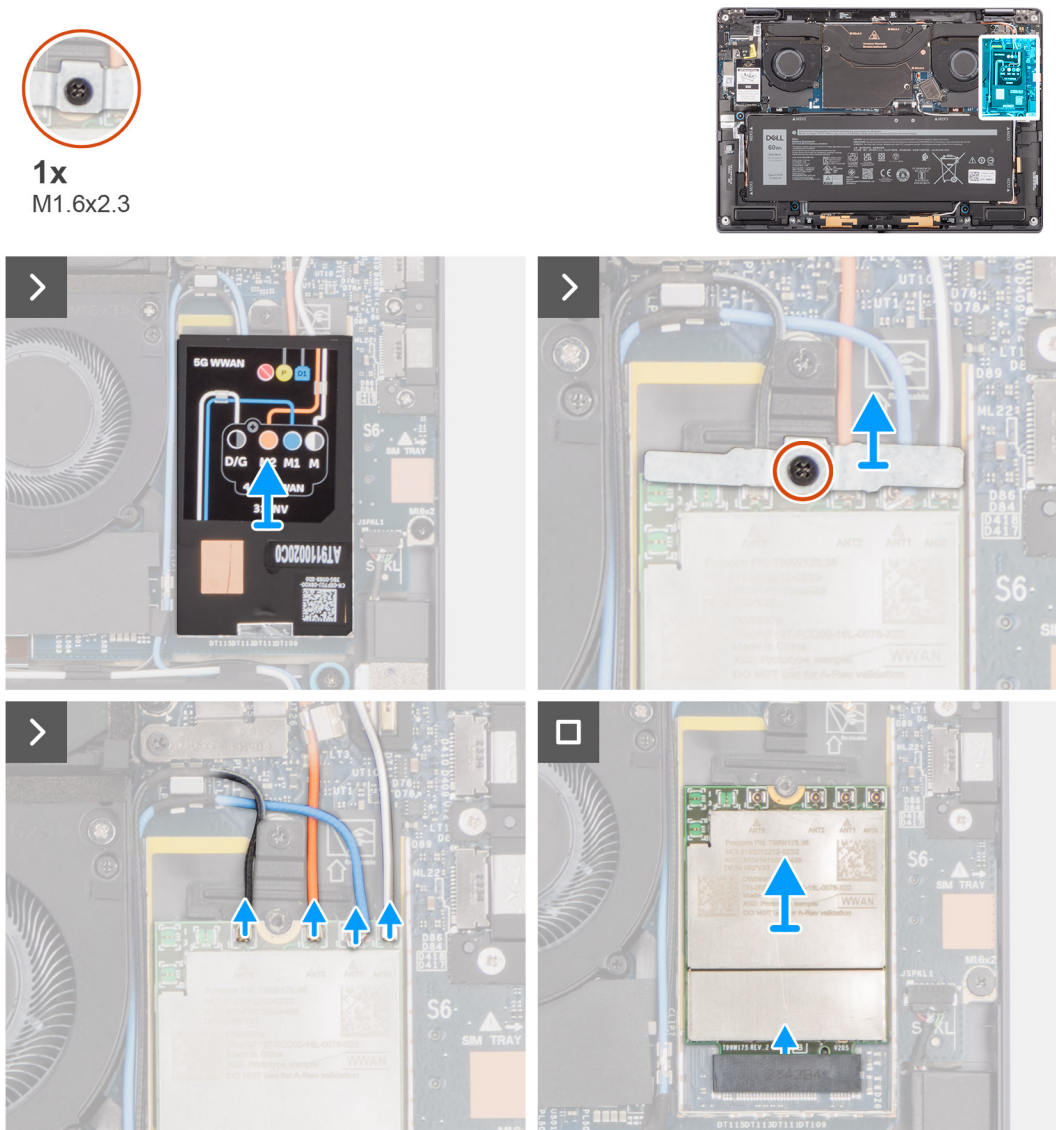

Figure 27. Removing the WWAN card

Steps

1. Using a plastic scribe, pry open the WWAN-card shielding cover starting from the right edge of the WWAN-card shielding cover.

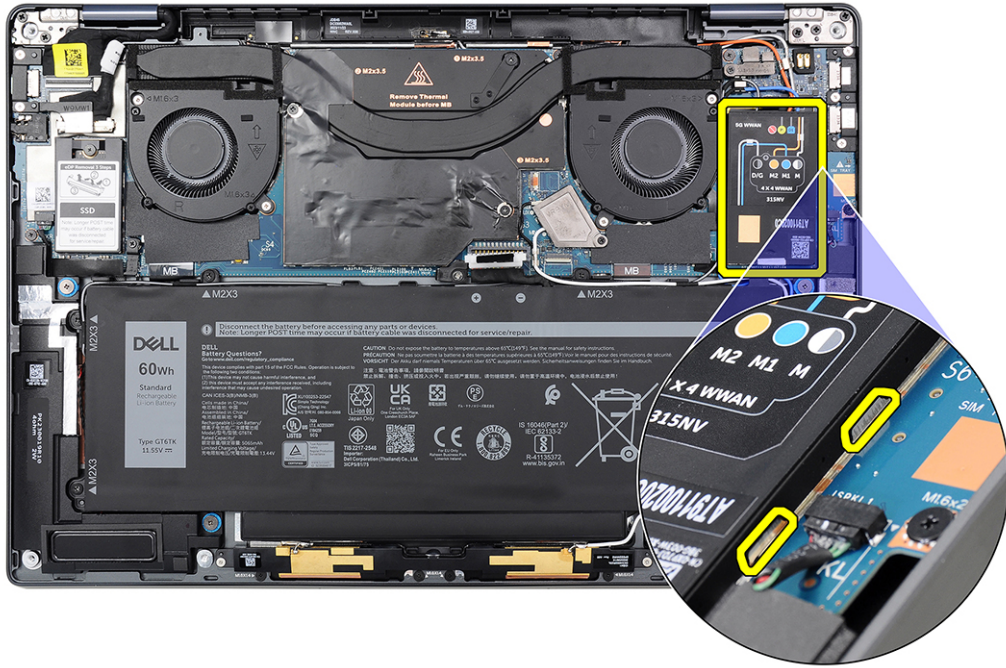

Figure 28. WWAN-card shielding cover

NOTE: A thermal pad is included with the WWAN-card shielding cover which must always be adhered to the cover. If the thermal pad gets separated from the cover or it adheres to the WWAN card during the removal procedure, you must readhere the thermal pad to the cover before installing the cover.



Figure 29. Thermal pad

2. Loosen the single M1.6x2.3 screw that secures the WWAN-card bracket to the frame on the system board.
3. Lift the WWAN-card bracket off the computer.
4. Disconnect the four antenna cables (D/G, M, M1, and M2) from the connectors (JNGFF2) at the top of the WWAN card.

- Slide and remove the WWAN card from the WWAN-card slot.

Installing the WWAN card

Prerequisites

If you are replacing a component, remove the existing component before performing the installation procedure.

About this task

The following image indicates the location of the WWAN card and provides a visual representation of the installation procedure.

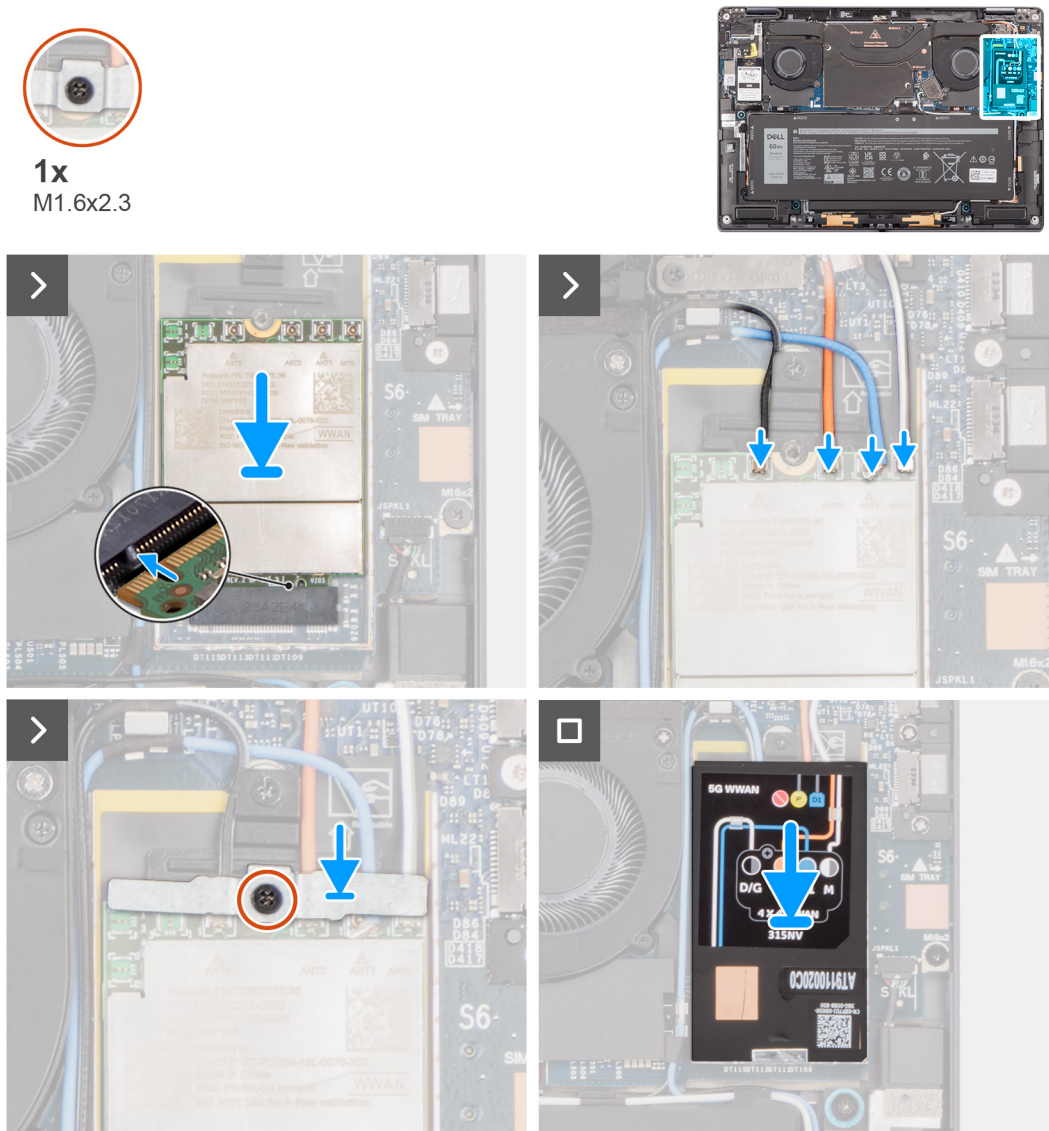



Figure 30. Installing the WWAN card

Steps

- Align the notch on the WWAN card with the tab on the WWAN-card slot.
 - NOTE:** If any of the thermal pads that are located underneath the WWAN card are detached from the system board when removing the WWAN card from the computer, adhere them back on the system board.
- Slide the WWAN card at an angle into the WWAN-card slot on the system board.
- Connect the four antenna cables (D/G, M, M1, and M2) to the connectors (JNGFF2) on the WWAN card.

4. Align and place the WWAN-card bracket with the frame on the system board and WWAN card, and tighten the single M1.6x2.3 screw.
5. Align and place the WWAN-card shielding cover over the WWAN card.
 **NOTE:** For instructions on how to find your computer's IMEI (International Mobile Station Equipment Identity) number, see the knowledge base article [000143678](#) at [Dell Support site](#).
6. Press the WWAN-card shielding cover to fix it firmly in place.

Next steps

1. Install the [base cover](#).
2. Install the [nano-SIM card tray](#), if applicable.
3. Follow the procedure in [after working inside your computer](#).

Removing and installing Field Replaceable Units (FRUs)

The replaceable components in this chapter are Field Replaceable Units (FRUs).

CAUTION: The information in this section is intended for authorized service technicians only.

CAUTION: To avoid any potential damage to the component or loss of data, ensure that an authorized service technician replaces the Field Replaceable Units (FRUs).

CAUTION: Dell Technologies recommends that this set of repairs, if needed, to be conducted by trained technical repair specialists.

CAUTION: As a reminder, your warranty does not cover damages that may occur during FRU repairs that are not authorized by Dell Technologies.

NOTE: The images in this document may differ from your computer depending on the configuration you ordered.

Battery

Rechargeable Li-ion battery precautions

CAUTION:

- Exercise caution when handling rechargeable Li-ion batteries.
- Discharge the battery completely before removing it. Disconnect the AC power adapter from the computer and operate the computer solely on battery power—the battery is fully discharged when the computer no longer turns on when the power button is pressed.
- Do not crush, drop, mutilate, or penetrate the battery with foreign objects.
- Do not expose the battery to high temperatures, or disassemble battery packs and cells.
- Do not apply pressure to the surface of the battery.
- Do not bend the battery.
- Do not use tools of any kind to pry on or against the battery.
- To prevent accidental puncture or damage to the battery and other components, ensure that no screws are lost or misplaced during the servicing of this product.
- If the battery gets stuck inside your computer as a result of swelling, do not try to release it as puncturing, bending, or crushing a rechargeable Li-ion battery can be dangerous. In such an instance, contact Dell technical support for assistance. See [Contact Support at Dell Support Site](#).
- Always purchase genuine batteries from [Dell Site](#) or authorized Dell partners and resellers.
- Swollen batteries should not be used and should be replaced and disposed properly. For guidelines on how to handle and replace swollen rechargeable Li-ion batteries, see [Handling swollen rechargeable Li-ion batteries](#).

Removing the battery

CAUTION: The information in this removal section is intended for authorized service technicians only.

Prerequisites

1. Follow the procedure in [before working inside your computer](#).
2. Remove the [nano-SIM card tray](#), if applicable.
3. Remove the [base cover](#).
4. Remove the [WWAN card](#).

NOTE: If the battery cable is disconnected from the system board for servicing, the date and time (RTC) of the computer will be reset. As a result, when the computer is turned on, you are prompted to set the date and time.

About this task

The following images indicate the location of the battery and provide a visual representation of the removal procedure.

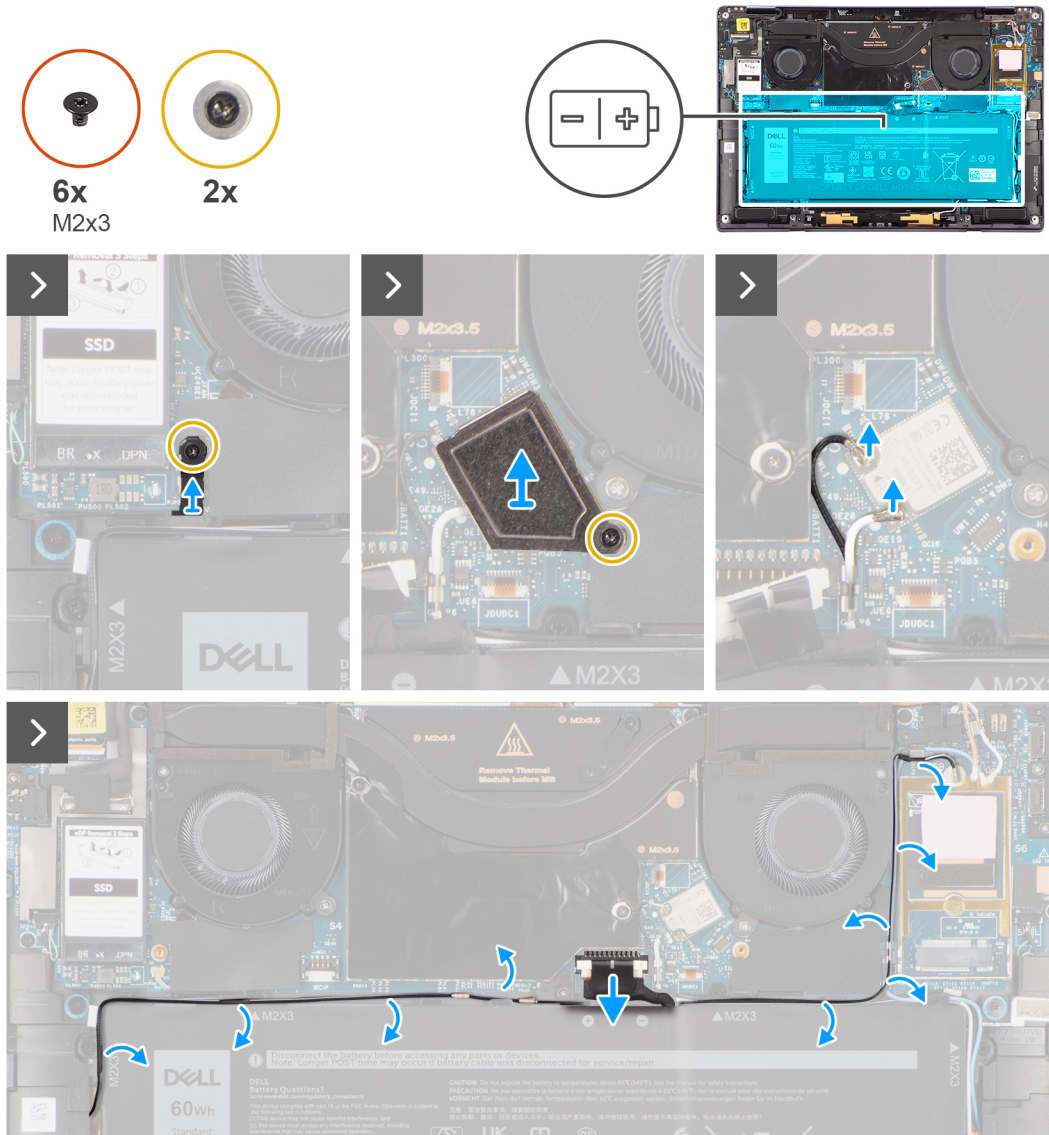

Figure 31. Removing the battery

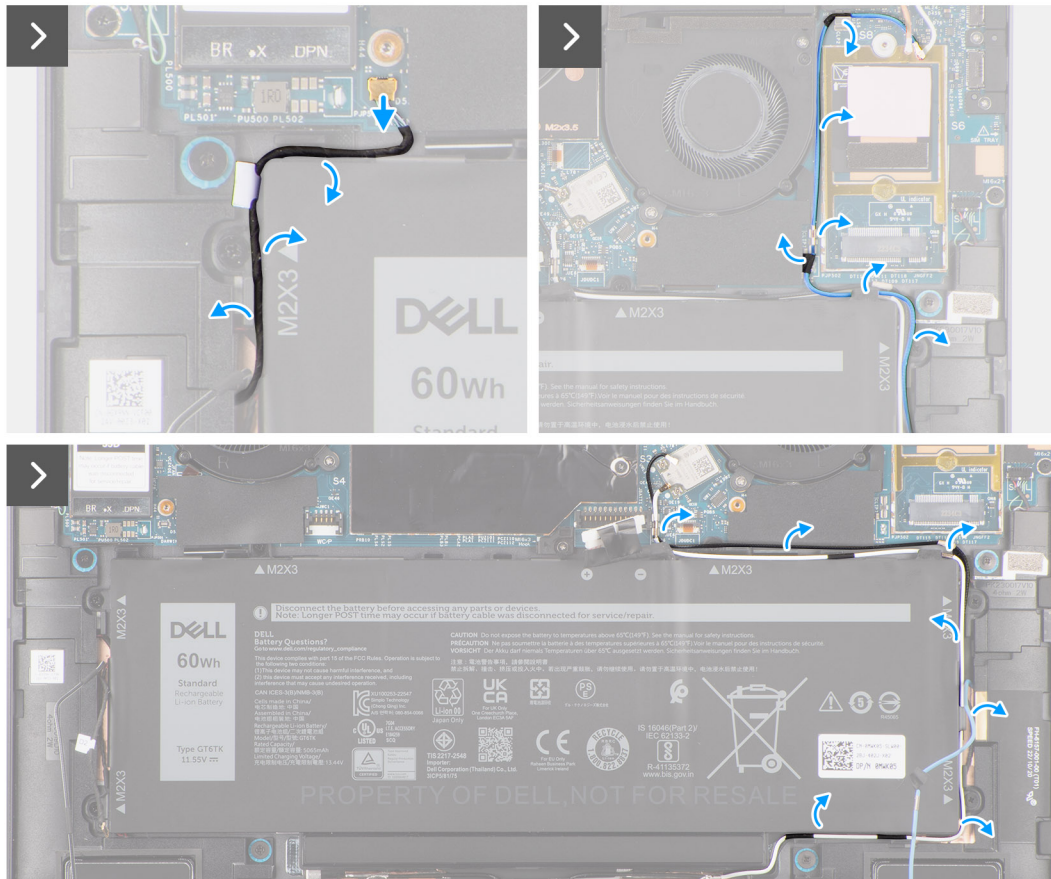

Figure 32. Removing the battery

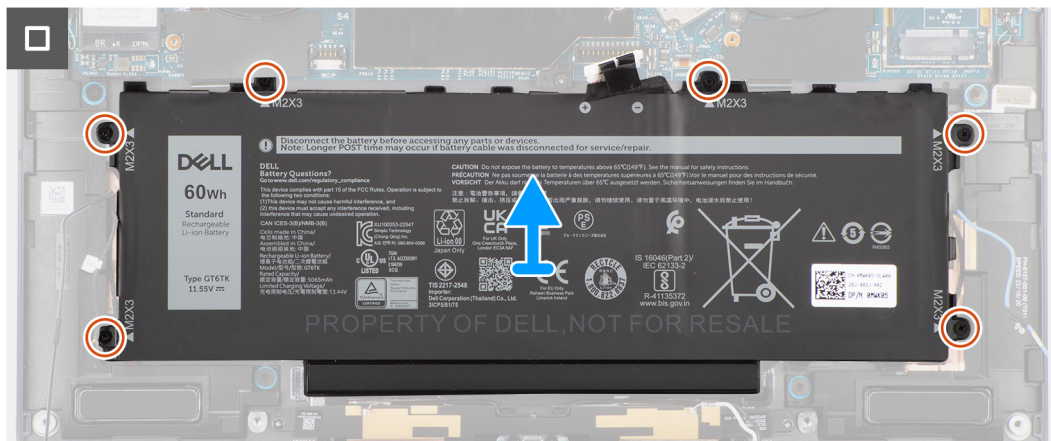

Figure 33. Removing the battery

Steps

1. Loosen the single M1.6x2.3 screw that secures the WWAN darwin bracket.
2. Lift the WWAN darwin bracket off the system board.
3. Loosen the captive screw that secures the WLAN bracket to the system board.
4. Lift the WLAN bracket off the system board.
5. Disconnect the two antenna cables (black and white) that are connected to the WLAN module.
6. Unroute the black/grey D/G WWAN antenna cable from the routing guides along the sides of the battery.
7. Disconnect the battery cable from the connector (BATTERY) on the system board.
8. Disconnect the Darwin cable (D2) and unroute it from the routing guides along the top side of the battery.

9. Unroute the two WWAN antenna cables (black and white) from the routing guides along the side of the battery.
10. Unroute the blue (M1) WWAN antenna cable from the routing guides along the left side of the WWAN card and the upper-right corner of the battery.
11. Remove the six (M2x3) screws that secure the battery to the palm-rest and keyboard assembly.
12. Lift the battery away from the computer.

Installing the battery

CAUTION: The information in this installation section is intended for authorized service technicians only.

Prerequisites

If you are replacing a component, remove the existing component before performing the installation procedure.

About this task

The following images indicate the location of the battery and provide a visual representation of the installation procedure.

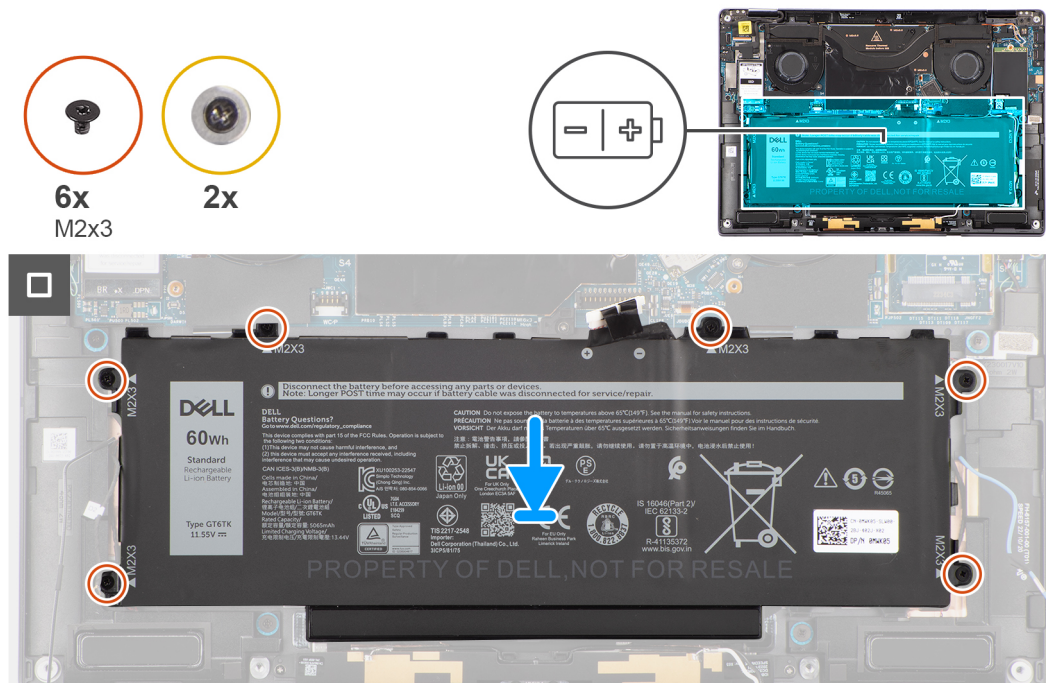

Figure 34. Installing the battery



Figure 35. Installing the battery

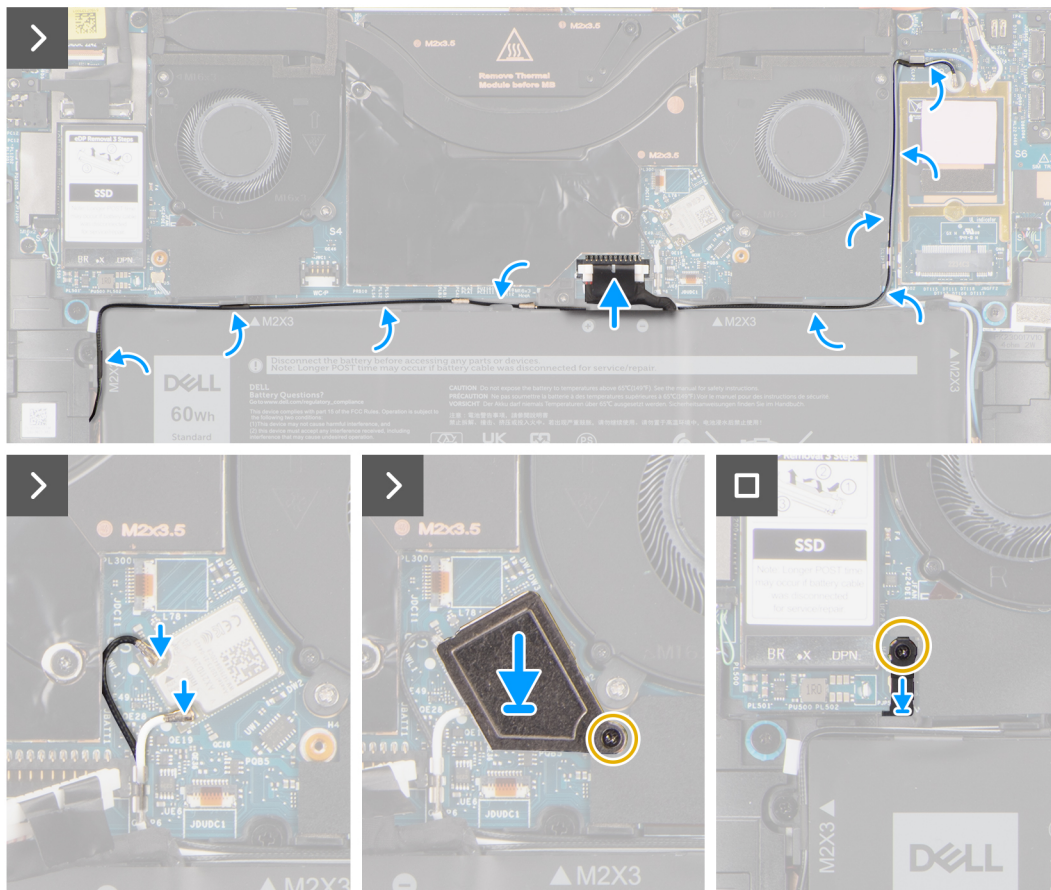

Figure 36. Installing the battery

Steps

1. Align and place the battery on the palm-rest and keyboard assembly.
2. Replace the six (M2x3) screw to secure the battery to the palm-rest and keyboard assembly.
3. Route the blue (M1) WWAN antenna cable in the routing guides along the left side of the WWAN card and the upper-right corner of the battery.
4. Route the two WWAN antenna cables (black and white) in the routing guides along the side of the battery.
5. Connect the Darwin cable (D2) and route it in the routing guides along the top side of the battery.
6. Route the black/grey D/G WWAN antenna cable in the routing guides along the sides of the battery.
7. Connect the two antenna cables (black and white) to the WLAN module.
8. Connect the battery cable to the connector (BATTERY) on the system board.
9. Align and place the WLAN bracket on the system board.
10. Tighten the captive screw that secures the WLAN bracket to the system board.
11. Align and place the WWAN Darwin bracket on the system board.
12. Replace the single M1.6x2.3 screw that secures the WWAN Darwin bracket.

Next steps

1. Install the [WWAN card](#), if applicable.
2. Install the [base cover](#).
3. Install the [nano-SIM card tray](#), if applicable.
4. Follow the procedure in [after working inside your computer](#).

Wireless Local Area Network (WLAN) antenna module

Removing the WLAN antenna module

Prerequisites

1. Follow the procedure in [before working inside your computer](#).
2. Remove the [nano-SIM card tray](#), if applicable.
3. Remove the [base cover](#).
4. Remove the [WWAN card](#), if applicable.
5. Remove the [battery](#).

About this task

The following image indicates the location of the WLAN antenna module and provides a visual representation of the removal procedure.

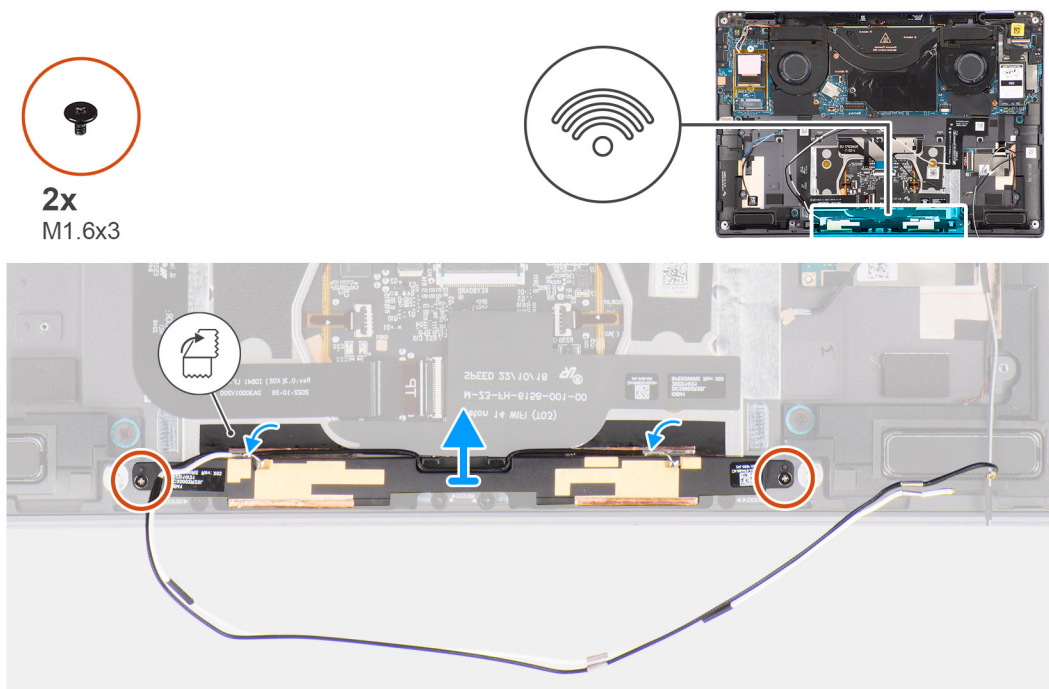

Figure 37. Removing the WLAN antenna module

Steps

1. Peel off the pieces of tape on either sides that secure the WLAN antenna module to the palm-rest and keyboard assembly.
2. Remove the two (M1.6x3) screws that secure the WLAN antenna module to the palm-rest and keyboard assembly.
3. Lift and remove the WLAN antenna module off the computer.

Installing the WLAN antenna module

Prerequisites

If you are replacing a component, remove the existing component before performing the installation procedure.

About this task

The following image indicates the location of the WLAN antenna module and provides a visual representation of the installation procedure.

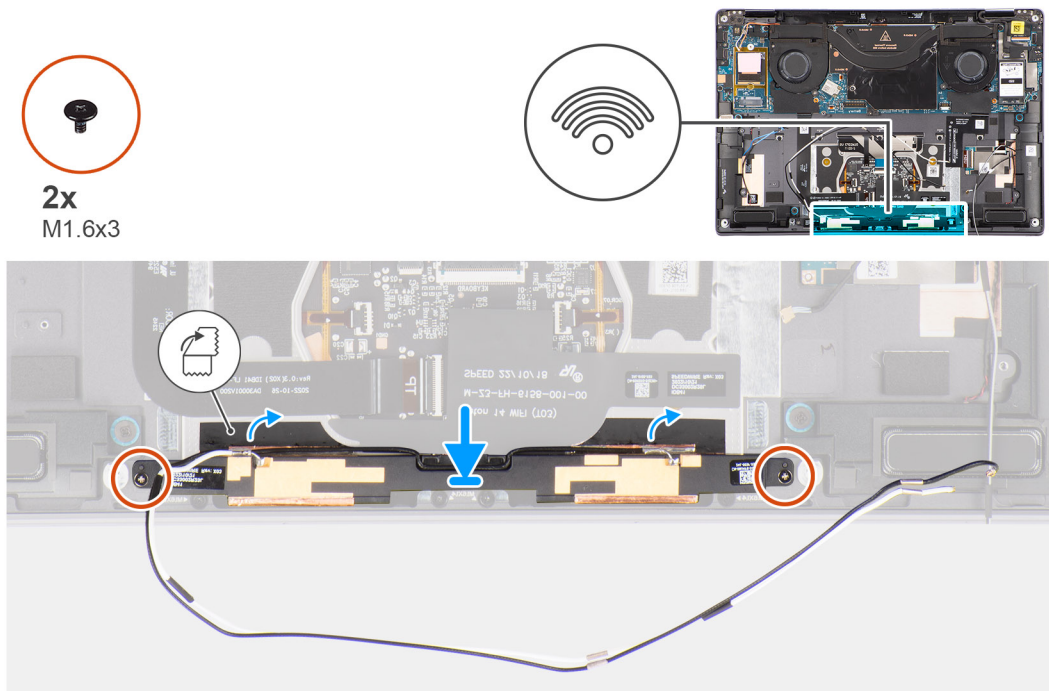

Figure 38. Installing the WLAN antenna module

Steps

1. Align and place the WLAN antenna module in the slot on the computer.
2. Replace the two (M1.6x3) screws to secure the WLAN antenna module to the palm-rest and keyboard assembly.
3. Adhere the pieces of tape on either sides that secure the WLAN antenna module to the palm-rest and keyboard assembly.

Next steps

1. Install the [battery](#).
2. Install the [WWAN card](#), if applicable.
3. Install the [base cover](#).
4. Install the [nano-SIM card tray](#), if applicable.
5. Follow the procedure in [after working inside your computer](#).

Heat sink

Removing the heat sink

⚠ CAUTION: The information in this removal section is intended for authorized service technicians only.

Prerequisites

1. Follow the procedure in [before working inside your computer](#).
2. Remove the [Nano-SIM card tray](#).
3. Remove the [base cover](#).

About this task

The following image indicates the location of the heat sink and provides a visual representation of the removal procedure.

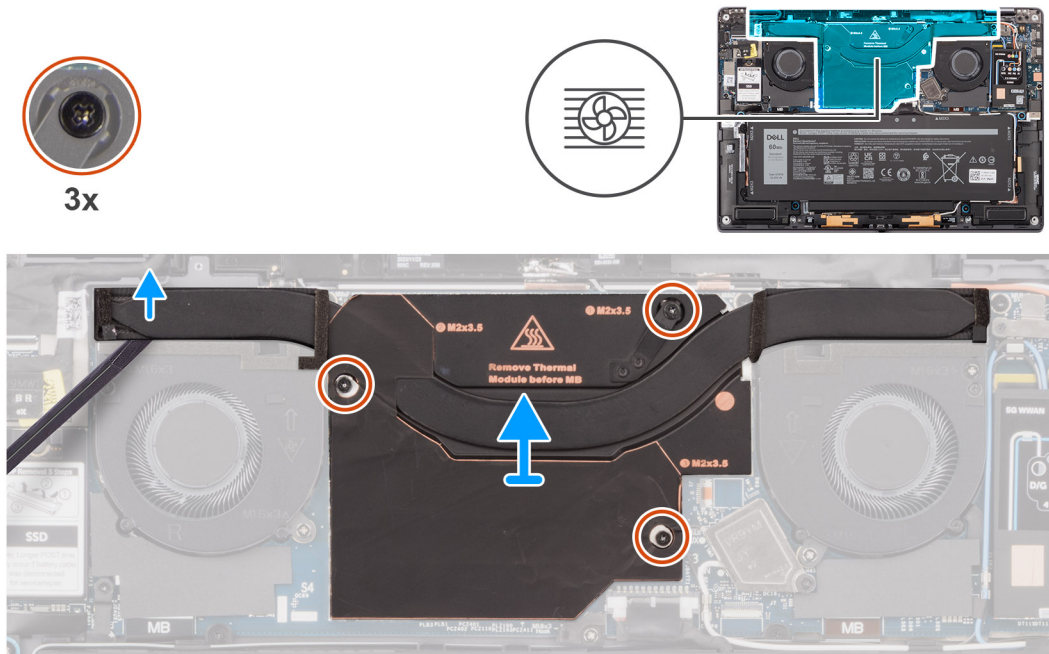

Figure 39. Removing the heat sink

Steps

1. Peel off the mylar sticker that secures the heat sink to the system board.
2. Loosen the three captive screws that secure the heat sink to the system board.
3. Using a plastic scribe, pry the left side of the bracket and remove the heat sink off the system board.

Installing the heat sink

CAUTION: The information in this installation section is intended for authorized service technicians only.

Prerequisites

If you are replacing a component, remove the existing component before performing the installation procedure.

About this task

The following image indicates the location of the heat sink and provides a visual representation of the installation procedure.

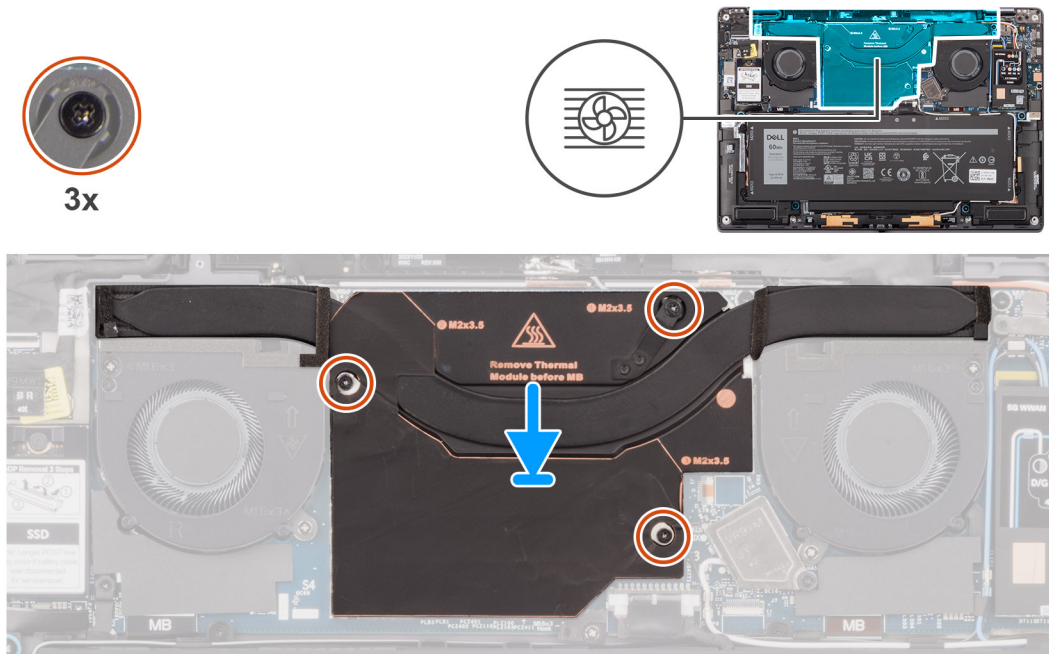

Figure 40. Installing the heat sink

NOTE: Ensure to replace the piece of foam extension one either sides of the bracket back in place after replacing the component. For more information, see [installing the left fan](#) and [installing the right fan](#).

Steps

1. Align the screw holes on the heat sink with the screw holes on the system board.
2. Tighten the three captive screws that secure the heat sink to the system board.
3. Peel back the mylar sticker that secures the heat sink to the system board.

Next steps

1. Install the [base cover](#).
2. Install the [Nano-SIM card slot](#).
3. Follow the procedure in [after working inside your computer](#).

Speaker

Removing the left speaker

CAUTION: The information in this removal section is intended for authorized service technicians only.

Prerequisites

1. Follow the procedure in [before working inside your computer](#).
2. Remove the [nano-SIM card tray](#), if applicable.
3. Remove the [base cover](#).
4. Remove the [WWAN card](#), if applicable.
5. Remove the [battery](#).

About this task

NOTE: For computers that are shipped with only WLAN card, the left speaker is a separate replaceable part. The following procedure is applicable only for computers that are shipped with the WLAN card.

The following image indicates the location of the left speaker and provides a visual representation of the removal procedure.

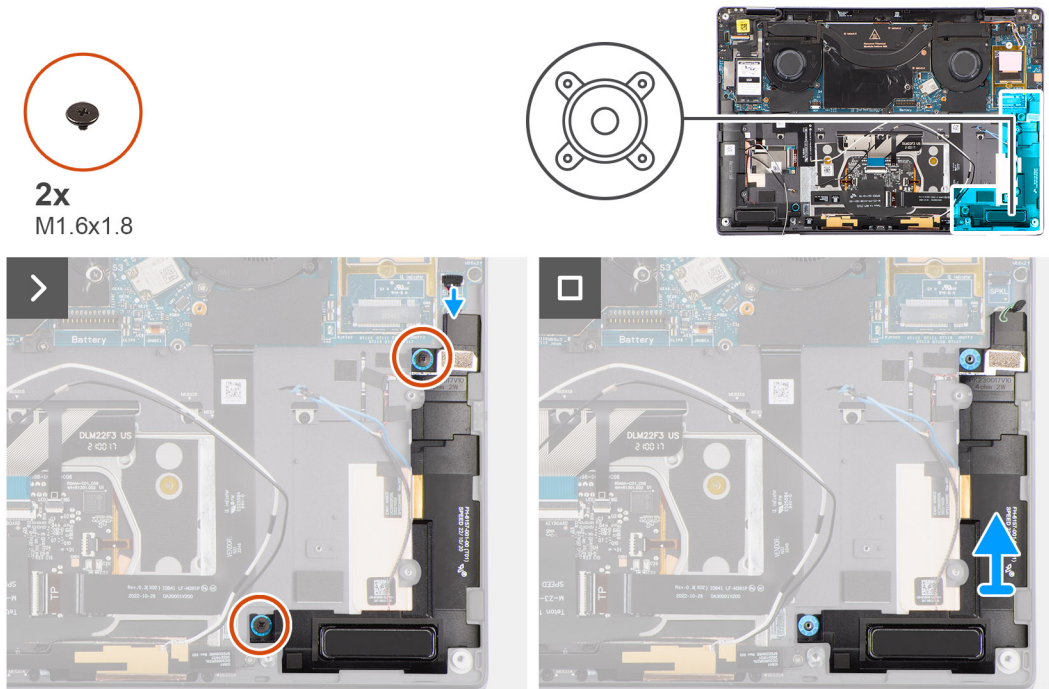

Figure 41. Removing the left speaker

Steps

1. Peel the tape that secures the left-speaker cable to the chassis.
2. Disconnect the left-speaker cable from the connector (SPKL) on the chassis.
3. Remove the two (M1.6x1.8) screws that secure the left speaker in place.
4. Lift the left speaker off the chassis.

Installing the left speaker

CAUTION: The information in this installation section is intended for authorized service technicians only.

Prerequisites

If you are replacing a component, remove the existing component before performing the installation procedure.

About this task

NOTE: For computers shipped with only WLAN card, the left speaker is a separate replaceable part. The following procedure is applicable only for computers that shipped with the WLAN card.

The following image indicates the location of the speaker and provides a visual representation of the installation procedure.

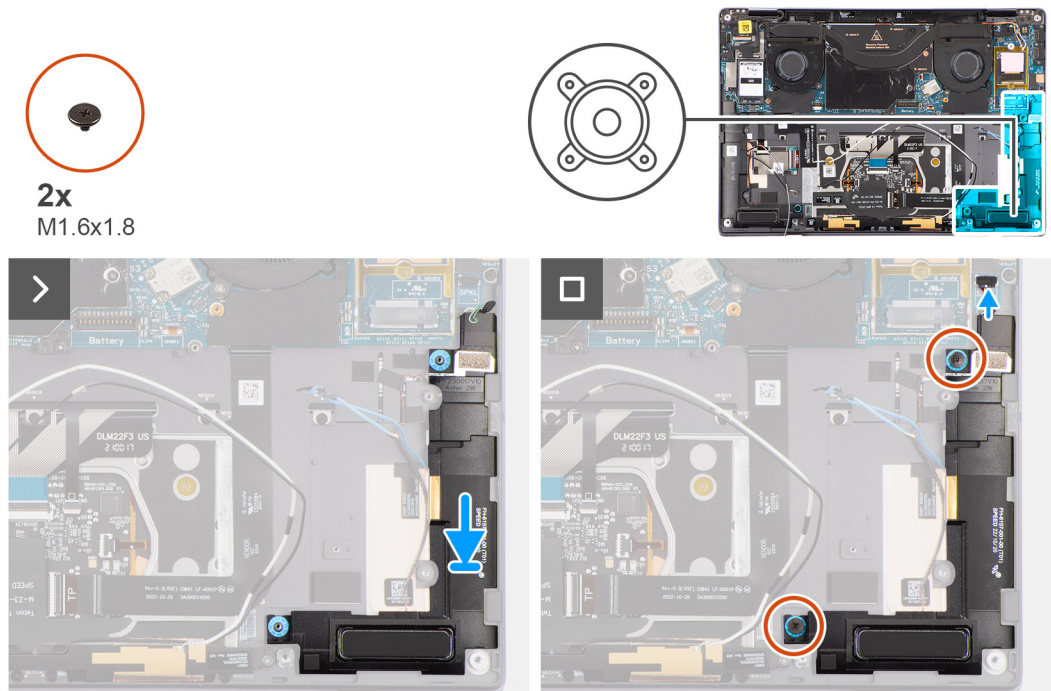

Figure 42. Installing the left speaker

Steps

1. Align and place the left speaker into the slot on the chassis.
2. Replace the two (M1.6x1.8) screws to secure the left speaker to the chassis.
3. Connect the left speaker cable to the connector (SPKL) on the system board.
4. Adhere the tape to secure the left speaker to the chassis.

When installing the right and left speakers, secure the speaker cables in place by adhering the pieces of tape to the palm-rest and keyboard assembly.

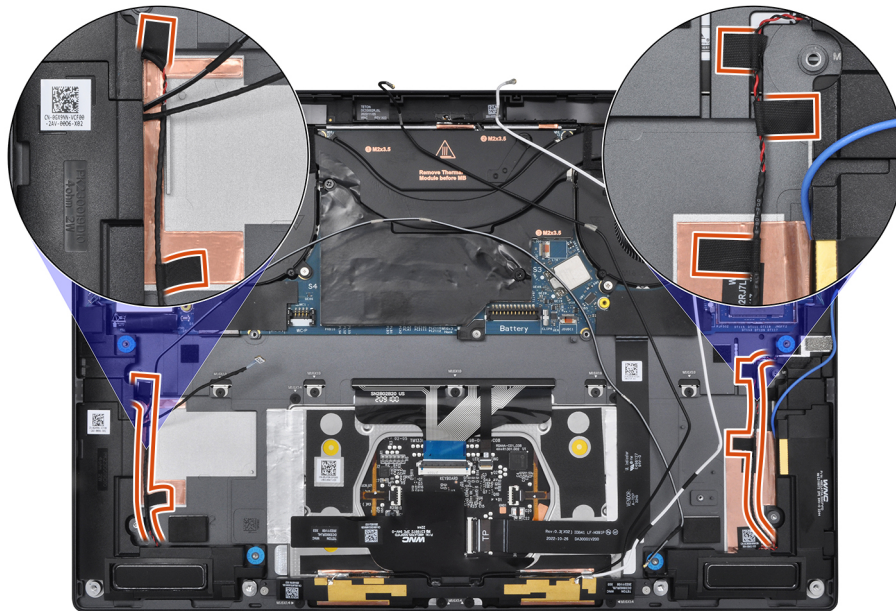

Figure 43. Speaker cable tape

Next steps

1. Install the [battery](#).
2. Install the [WWAN card](#), if applicable.
3. Install the [base cover](#).
4. Install the [nano-SIM card tray](#), if applicable.
5. Follow the procedure in [after working inside your computer](#).

Removing the right speaker

CAUTION: The information in this removal section is intended for authorized service technicians only.

Prerequisites

1. Follow the procedure in [before working inside your computer](#).
2. Remove the [nano SIM-card tray](#), if applicable.
3. Remove the [base cover](#).
4. Remove the [WWAN card](#), if applicable.
5. Remove the [battery](#).

About this task

The following image indicates the location of the speaker and provides a visual representation of the removal procedure.

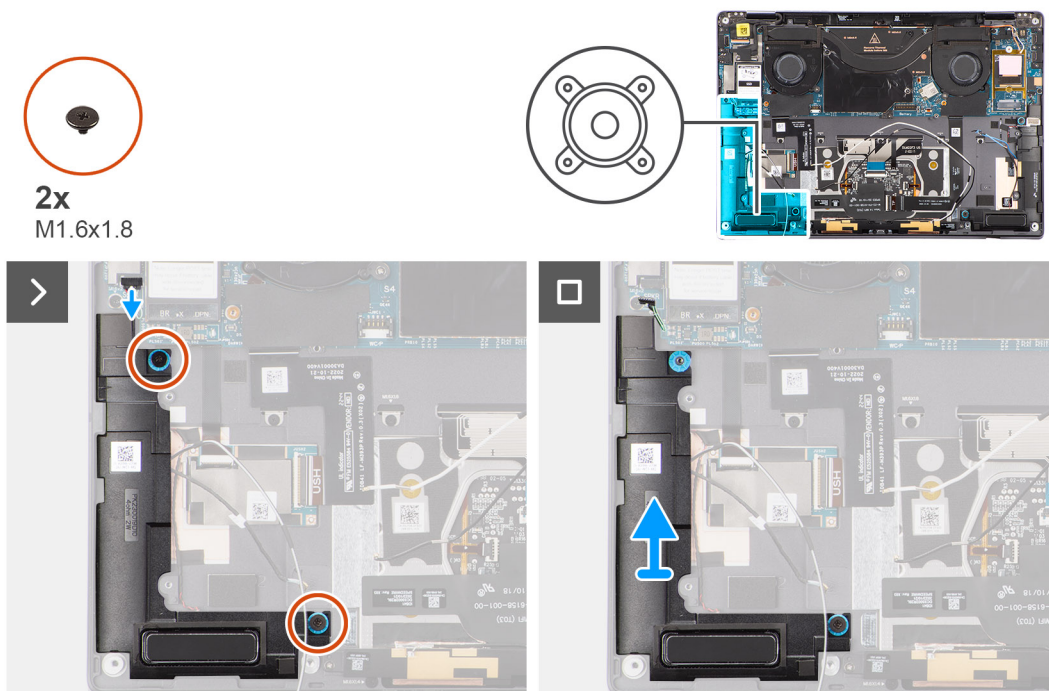

Figure 44. Removing the right speaker

Steps

1. Peel the tape securing the right speaker cable to the chassis.
2. Remove the two (M1.6x1.8) screws that secure the right speaker in place.
3. Disconnect the right speaker cable from the connector (SPKR) on the system board.
4. Lift the right speaker off the palm-rest assembly.

Installing the right speaker

CAUTION: The information in this installation section is intended for authorized service technicians only.

Prerequisites

If you are replacing a component, remove the existing component before performing the installation procedure.

About this task

The following image indicates the location of the speaker and provides a visual representation of the installation procedure.

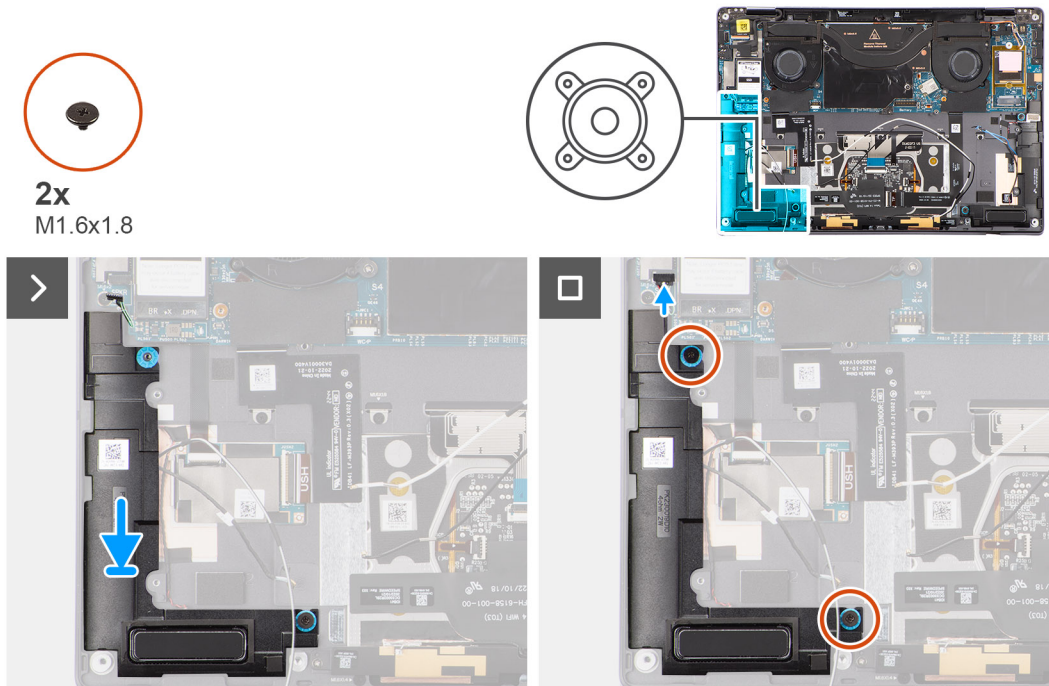

Figure 45. Installing the right speaker

Steps

1. Align and place the right speaker into the slot on the chassis.
2. Replace the two (M1.6x1.8) screws to secure the right speaker to the chassis.
3. Connect the right speaker cable to the connector (SPKR) on the system board.
4. Adhere the tape to secure the right speaker cable to the palm-rest and keyboard assembly.

When installing the right speaker, secure the speaker cables in place by adhering the pieces of tape to the palm-rest and keyboard assembly.

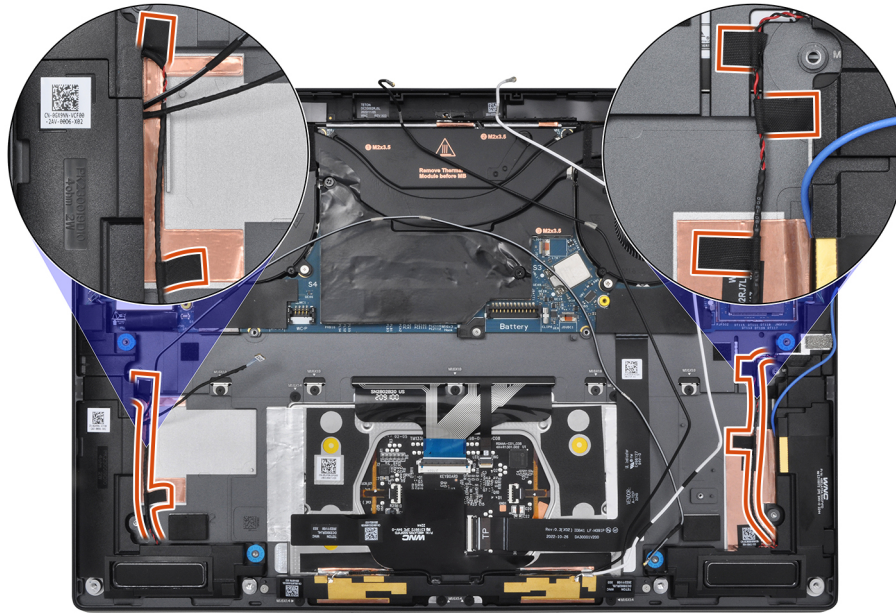

Figure 46. Speaker cable tape

Next steps

1. Install the [battery](#).
2. Install the [WWAN card](#) if applicable.
3. Install the [base cover](#).
4. Install the [nano-SIM card tray](#), if applicable.
5. Follow the procedure in [after working inside your computer](#).

Display assembly

Removing the display assembly

⚠ CAUTION: The information in this removal section is intended for authorized service technicians only.

Prerequisites

1. Follow the procedure in [before working inside your computer](#).
2. Remove the [nano-SIM card tray](#), if applicable.
3. Remove the [base cover](#).

About this task

The following images indicate the location of the display assembly and provide a visual representation of the removal procedure.

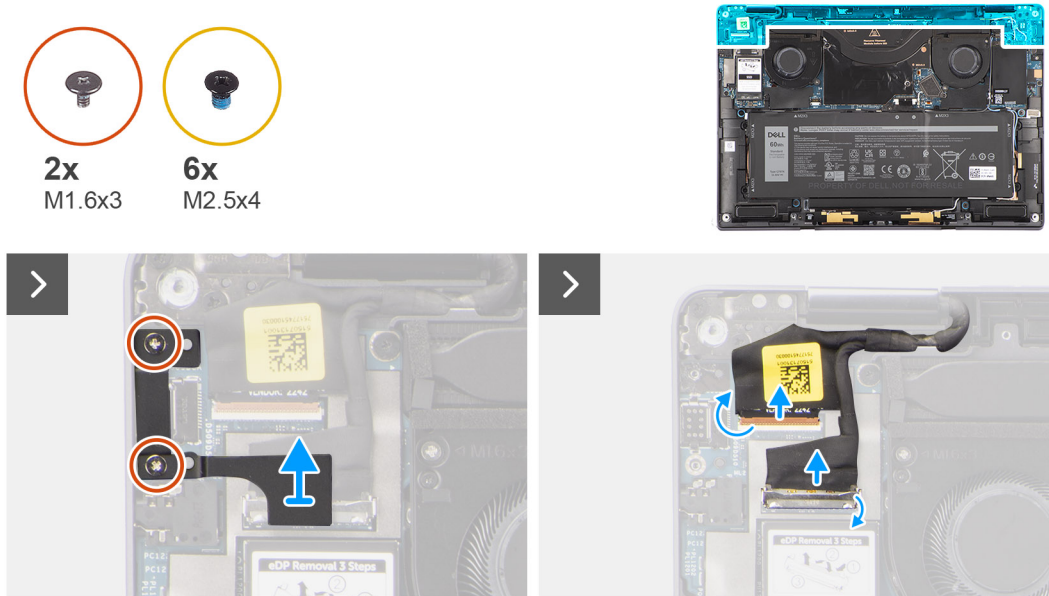

Figure 47. Removing the display assembly

Steps

1. Remove the two (M1.6x3) screws that secure the display cable/Type-C bracket in place.
2. Disconnect the battery cable from the battery-cable connector (BATTERY) on the system board.
3. Lift the display cable/Type-C bracket off the system board.
4. Disconnect the camera cable and display cable from the connectors (CAMERA and EDP respectively) on the system board.

NOTE: The connector for the display cable uses a latch that locks it in place on the system board which technicians must flip open to disconnect the display cable from the system board. After flipping open the latch, technicians must grasp the left and right sides of the cable's connector head and disconnect the display cable from the system board in a direct upward motion to prevent damage to the connector's pins.

CAUTION: Do not attempt to disconnect the display cable from the connector on the system board without flipping open the latch first.



Figure 48. Disconnecting the display cable

5. Open the display assembly to a 90-degree angle and lay the computer on the edge of the table so the palm-rest and keyboard assembly is laying flat on the table and the display assembly is over the edge.



Figure 49. Removing the display assembly

6. Remove the six (M2.5x4) screws that secure the display assembly to the computer.
7. Press the edges of the system near the hinges, and lift the hinges in the upward direction away from the computer.
8. Lift the display assembly off the computer.

NOTE: The display assembly is a Hinge-Up Design (HUD) assembly and it cannot be further disassembled once it is removed from the bottom chassis. If any components in the display assembly are malfunctioning and must be replaced, replace the entire display assembly.

Installing the display assembly

CAUTION: The information in this installation section is intended for authorized service technicians only.

Prerequisites

If you are replacing a component, remove the existing component before performing the installation procedure.

About this task

The following images indicate the location of the display assembly and provide a visual representation of the installation procedure.



2x
M1.6x3



6x
M2.5x4

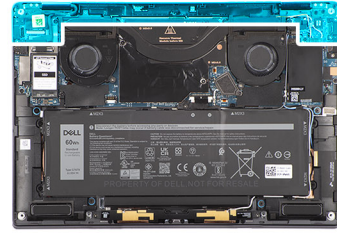

Figure 50. Installing the display assembly



Figure 51. Installing the display assembly

Steps

1. Align and place the palm-rest and keyboard assembly under the hinges of the display assembly.
2. Replace the six (M2.5x4) screws to secure the display assembly to the computer.
3. Connect the camera and display cables to the connectors (CAMERA and EDP respectively) on the system board.
4. Align and place the display cable/Type-C bracket over the screw holes on the system board.
5. Replace the two (M1.6x3) screws to secure the display cable/Type-C bracket in place.
6. Connect the battery cable to the battery-cable connector (BATTERY) on the system board.

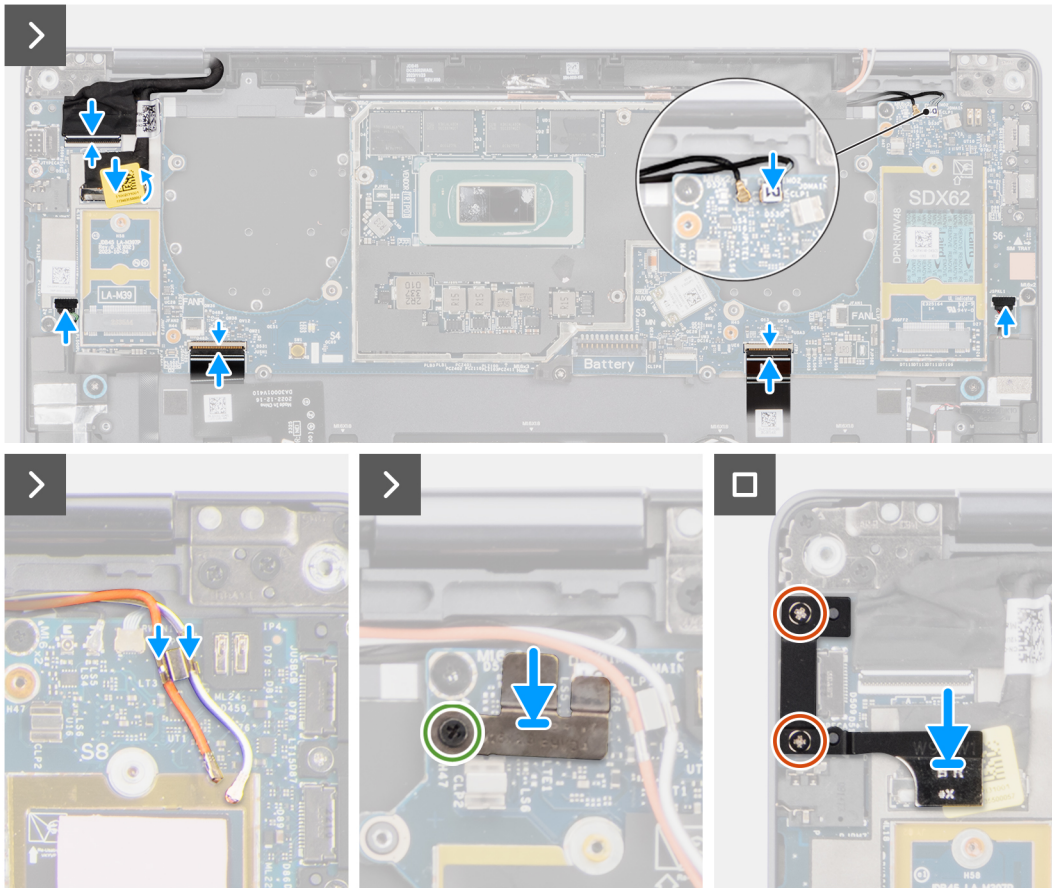

Figure 52. Installing the display assembly

Next steps

1. Install the [base cover](#).
2. Install the [nano-SIM card tray](#).
3. Follow the procedure in [after working inside your computer](#).

System board

Removing the system board

CAUTION: The information in this removal section is intended for authorized service technicians only.

Prerequisites

1. Follow the procedure in [before working inside your computer](#)
2. Remove the [Nano-SIM card tray](#), if applicable.
3. Remove the [base cover](#).
4. Remove the [solid state drive](#).
5. Remove the [WWAN card](#), if applicable.
6. Remove the [right fan](#).
7. Remove the [left fan](#).
8. Remove the [heat sink](#).
9. Remove the [battery](#).

About this task

CAUTION: The heat sink must be removed first before removing the system board, as there are two (M1.6x2) screws underneath the heat sink that secure the system board to the chassis.

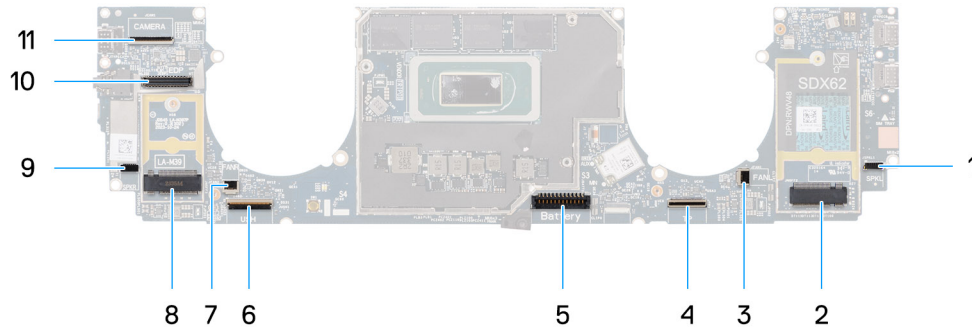

Figure 53. System board

1. Speaker-cable connector (SPKL)
2. WWAN-card connector (JNGFF2)
3. Fan-cable connector (FANL)
4. Touchpad-cable connector (TP)
5. Battery-cable connector (Battery)
6. USH I/O board-cable connector (USH)
7. Fan-cable connector (FANR)
8. M.2 2230 solid state drive connector (LA-M39)
9. Speaker-cable connector (SPKR)
10. Display-cable connector (EDP)
11. Camera-cable connector (CAMERA)

The following images indicate the location of the system board and provide a visual representation of the removal procedure.

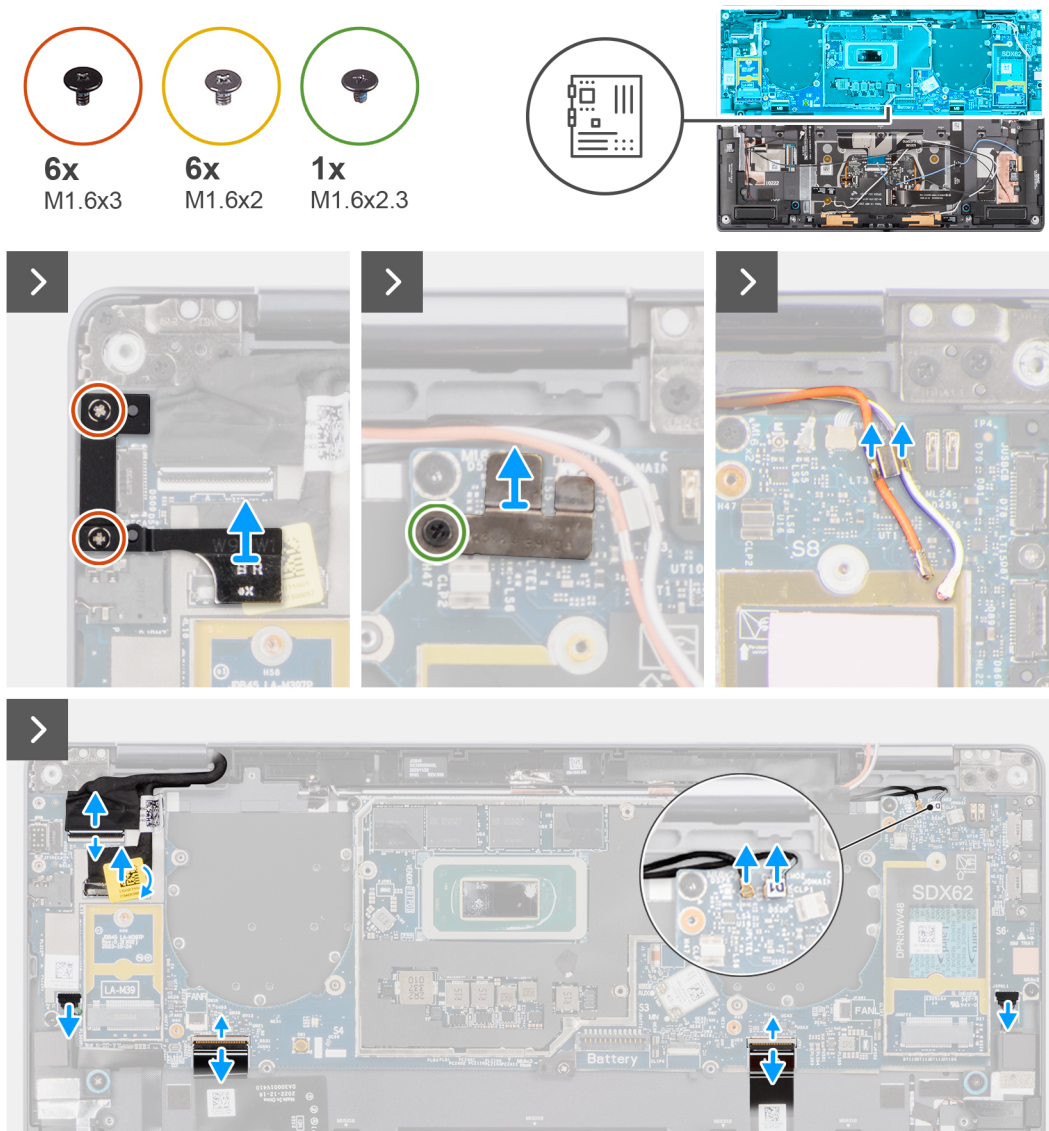

Figure 54. Removing the system board

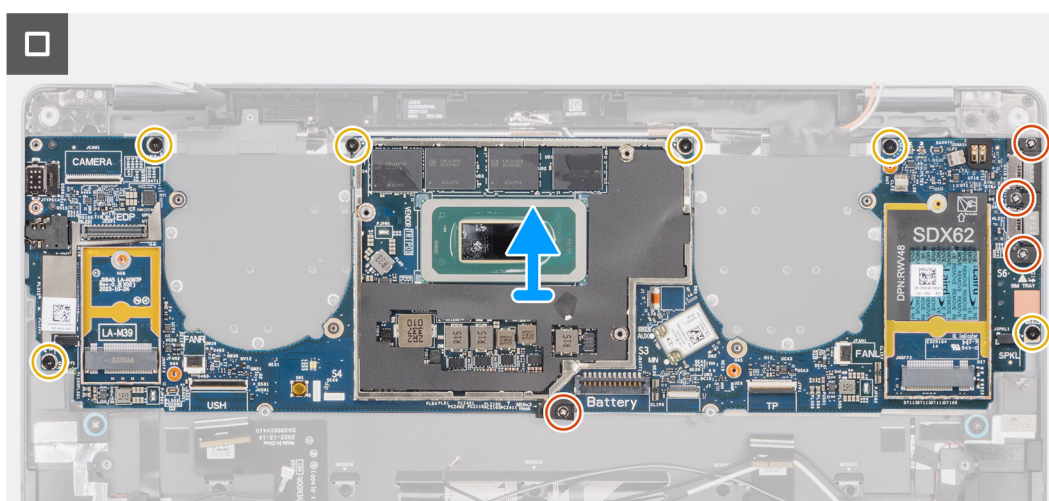

Figure 55. Removing the system board

Steps

1. Remove the two (M1.6x3) screws that secure the display cable/Type-C bracket in place.
2. Lift the display cable/Type-C bracket off the system board.
3. For computers shipped with the WWAN card:
 - a. Loosen the single (M1.6x2.3) screw that secures the WWAN Darwin bracket to the system board.
 - b. Lift the WWAN Darwin bracket off the system board.
4. Disconnect the following from their connectors on the system board:
 - Display cable
 - Camera cable
 - Proximity sensor cable
 - Darwin (D1) antenna cable (for computers that shipped with the WWAN card)
 - Left-speaker cable
 - Right-speaker cable
 - Touchpad-FPC cable
 - Power-button FPC cable (for computers shipped without fingerprint reader) or USH I/O-board FPC cable (for computers shipped with a fingerprint reader)

NOTE: The connector for the display cable and camera cable features a latch that locks it in place on the system board which technicians must flip open in order to disconnect the display cable and camera cable from the system board. After flipping open the latch, technicians must grasp the left and right sides of the cables' connector head and disconnect the cables from the system board in a direct upward motion to prevent damage to the connector's pins.

CAUTION: Do not attempt to disconnect the display cable and camera cable from the system board without flipping open the latch first.



Figure 56. Display cable

5. For computers shipped with the WWAN card, unroute the white/grey (M) and orange (M2) WWAN antenna cables from their routing guides on the system board.
6. Remove the three (M1.6x3) screws that secure the USB Type-C bracket to the system board.
7. Lift the USB Type-C bracket off the system board.
8. Remove the single (M1.6x3) screw and six (M1.6x2) screws that secure the system board to the palm-rest assembly.
There are seven screws in two different sizes that secure the system board in place.

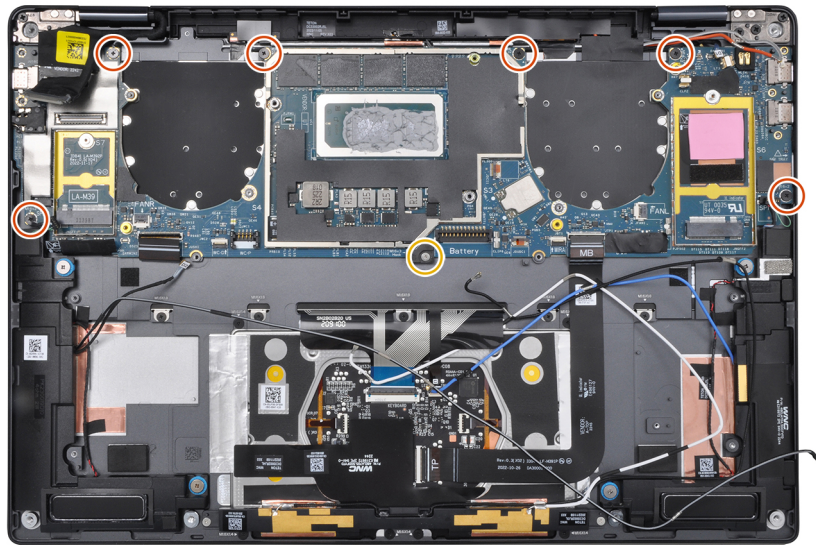

Figure 57. System board

- Remove the system board off the palm-rest and keyboard assembly.

CAUTION: Do not hold and bend the system board from its neck as it may damage the system board.

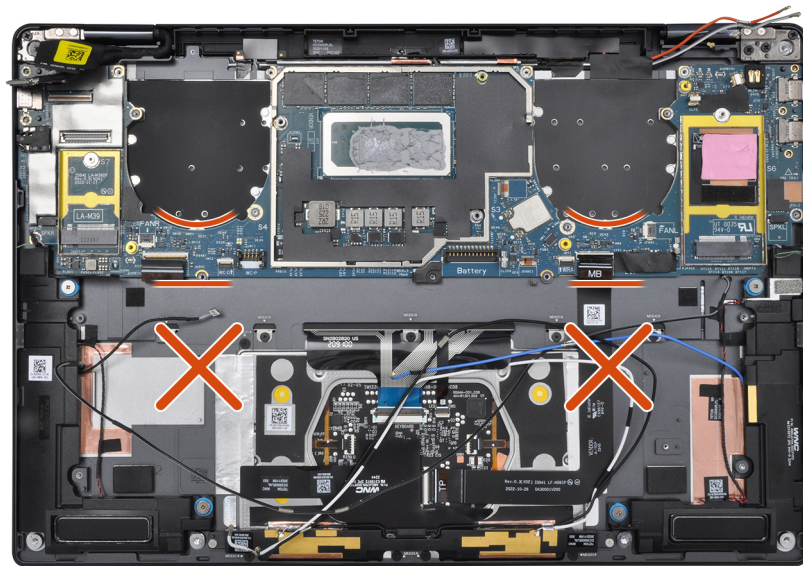

Figure 58. System board

- Peel back the display absorber and WWAN thermal pad (for computers shipped with the WWAN card) from the system board.

NOTE: The following reusable items MUST be transferred immediately to the replacement system board.



Figure 59. Display absorber and WWAN thermal pad

1. Display absorber (for computers shipped with WWAN card) or display mylar (for computers shipped without WWAN card)
2. WWAN card thermal pad sticker (for computers shipped with WWAN card)

Installing the system board

CAUTION: The information in this installation section is intended for authorized service technicians only.

Prerequisites

If you are replacing a component, remove the existing component before performing the installation procedure.

About this task

The following image indicates the location of the system board and provides a visual representation of the installation procedure.

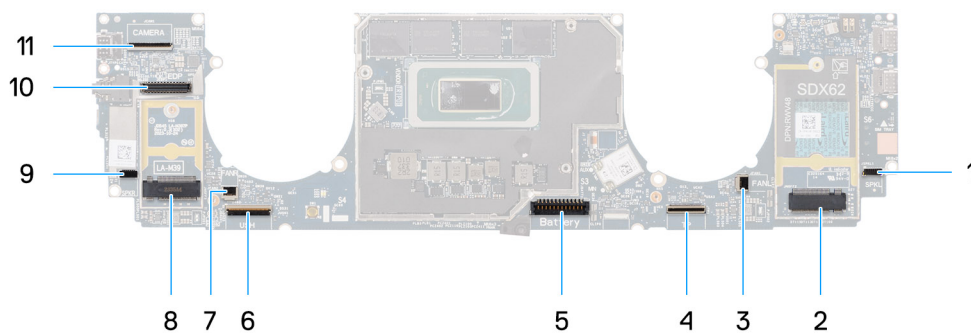

Figure 60. Installing the system board

1. Speaker-cable connector (SPKL)
2. WWAN-card connector (JNGFF2)
3. Fan-cable connector (FANL)
4. Touchpad-cable connector (TP)
5. Battery-cable connector (Battery)
6. USH I/O board-cable connector (USH)
7. Fan-cable connector (FANR)
8. M.2 2230 solid state drive connector (LA-M39)
9. Speaker-cable connector (SPKR)
10. Display-cable connector (EDP)
11. Camera-cable connector (CAMERA)

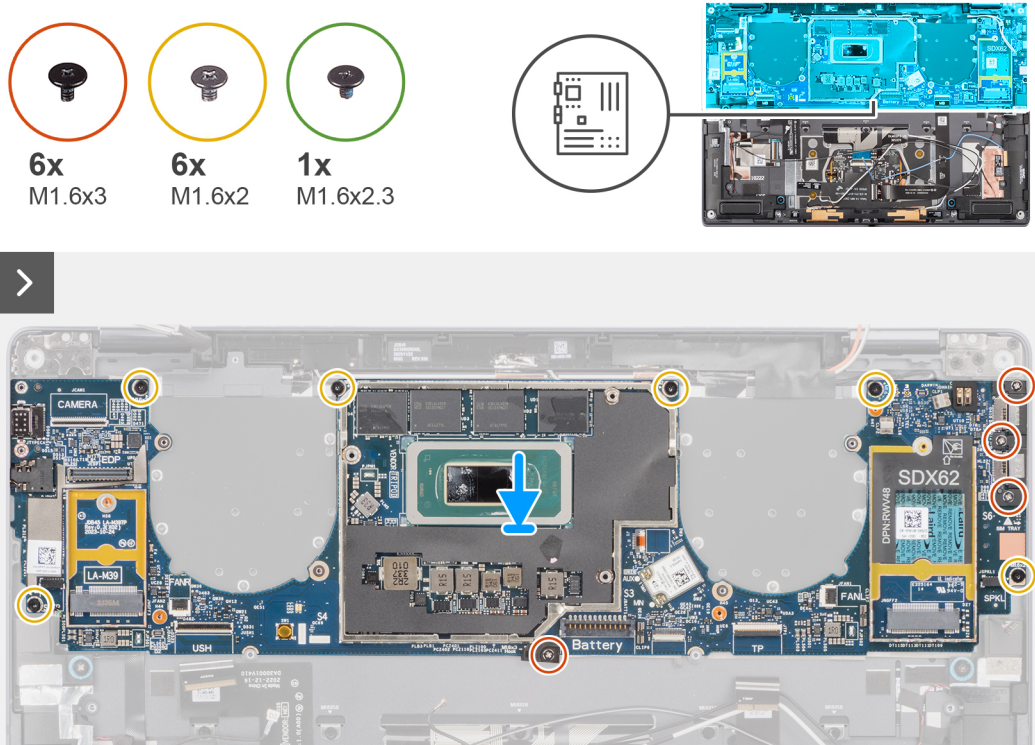

Figure 61. Installing the system board

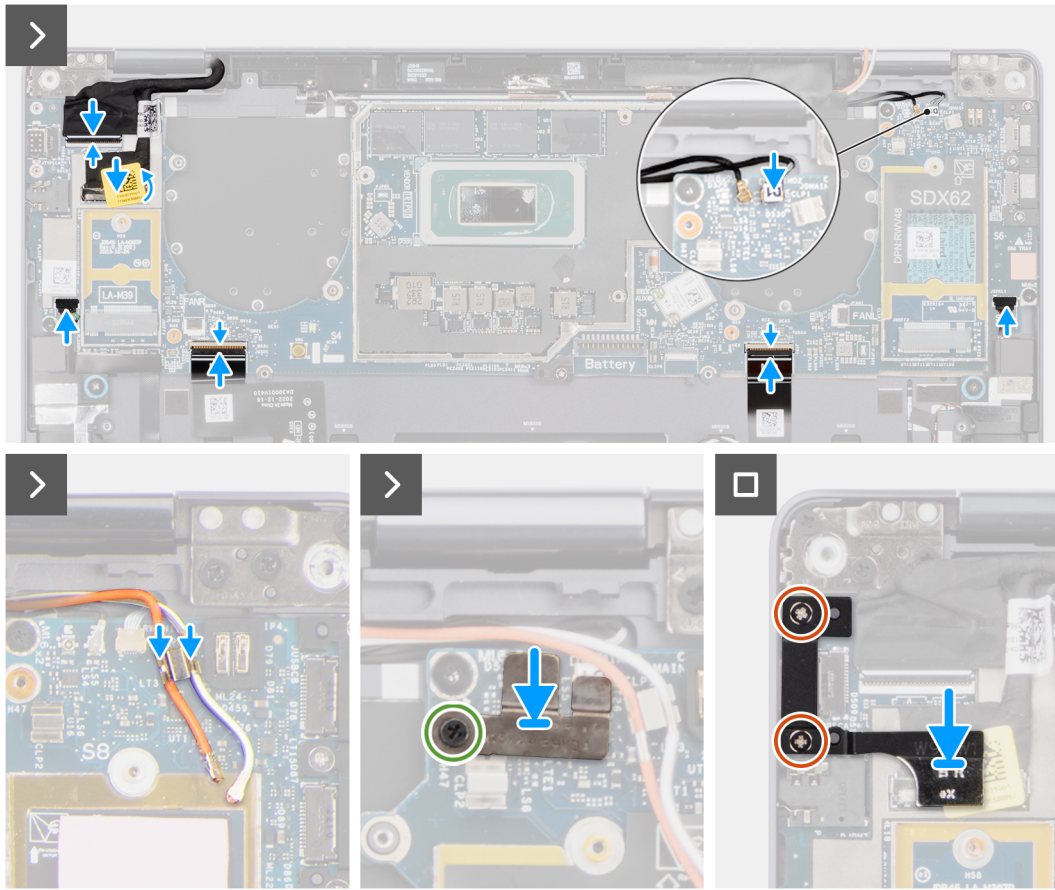

Figure 62. Installing the system board

Steps

1. Adhere the display absorber and WWAN thermal pad (for computers shipped with the WWAN card) on the system board.

NOTE: The following reusable items MUST be transferred immediately to the replacement system board.



Figure 63. Display absorber and WWAN thermal pad

1. Display absorber (for computers shipped with WWAN card) or display mylar (for computers shipped without WWAN card)
 2. WWAN card thermal pad sticker (for models shipped with the WWAN card)
2. Align and place the system board on the palm-rest and keyboard assembly.

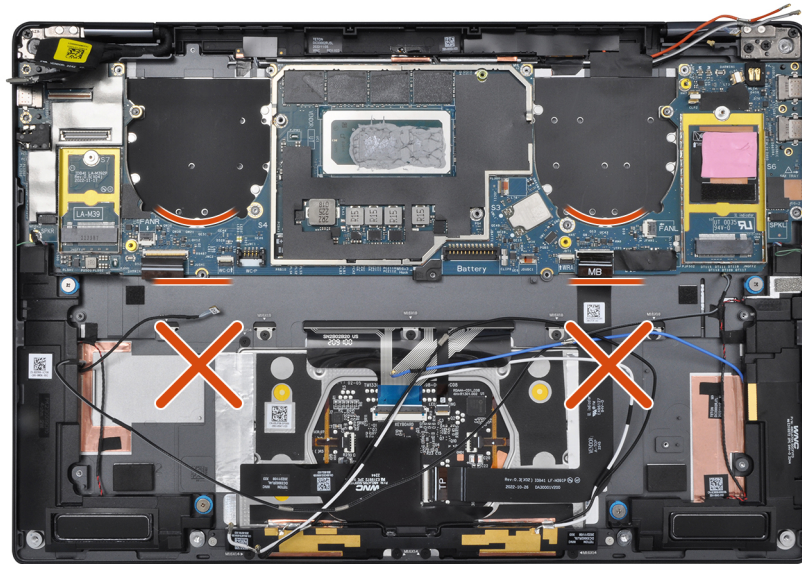

Figure 64. System board

CAUTION: Do not hold and bend the system board from its necks as it may damage the system board.

3. Replace the single (M1.6x3) screw and six (M1.6x2) screws to secure the system board to the palm-rest and keyboard assembly.

NOTE: There are seven screws in two different sizes that secure the system board in place.

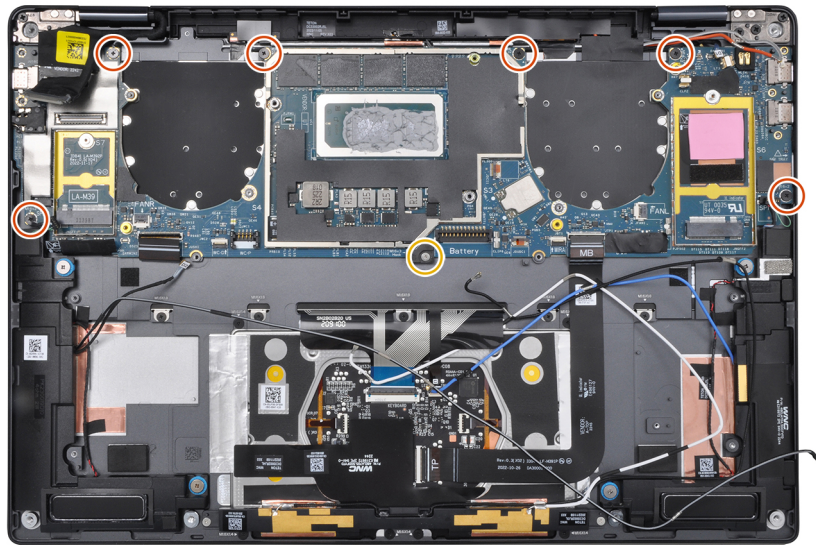

Figure 65. System board

4. Align and place the USB Type-C bracket on the system board.
 5. Replace the three (M1.6x3) screws to secure the USB Type-C bracket to the system board.
 6. For computers shipped with the WWAN card, route the white/grey (M) and orange (M2) WWAN antenna cables through their routing guides on the system board.
 7. Connect the following to their connectors on the system board:
 - Display cable
 - Camera cable
 - Proximity sensor cable
 - Darwin (D1) antenna cable (for computers that shipped with the WWAN card)
 - Left-speaker cable
 - Right-speaker cable
 - Touchpad-FPC cable
 - Power-button FPC cable (for computers shipped without fingerprint reader) or USH I/O-board FPC cable (for computers shipped with a fingerprint reader)
- NOTE:** The connector for the display cable and camera cable features a latch that locks it in place on the system board which technicians must close to connect the cables to the system board.
8. For computers shipped with the WWAN card:
 - a. Align and place the display cable/Type-C bracket on the system board.
 - b. Tighten the single (M1.6x2.3) screw to secure the WWAN Darwin bracket to the system board.
 9. Replace the two (M1.6x3) screws to secure the display cable/Type-C bracket in place.
 10. Adhere the left and right mylar stickers on the system board.

Next steps

1. Install the [battery](#).
2. Install the [heat sink](#).
3. Install the [left fan](#).
4. Install the [right fan](#).
5. Install the [WWAN card](#), if applicable.
6. Install the [solid state drive](#).
7. Install the [base cover](#).
8. Install the [nano-SIM card tray](#), if applicable.
9. Follow the procedure in [after working inside your computer](#).

Power button with fingerprint-reader assembly

Removing the power button with fingerprint-reader assembly

CAUTION: The information in this removal section is intended for authorized service technicians only.

Prerequisites

1. Follow the procedure in [before working inside your computer](#).
2. Remove the [nano-SIM card tray](#), if applicable.
3. Remove the [base cover](#).
4. Remove the [solid state drive](#).
5. Remove the [WWAN card](#), if applicable.
6. Remove the [right fan](#).
7. Remove the [left fan](#).
8. Remove the [display assembly](#).
9. Remove the [heat sink](#).
10. Remove the [battery](#).
11. Remove the [system board](#).

About this task

The following image indicates the location of the power-button with fingerprint-reader assembly and provides a visual representation of the removal procedure.

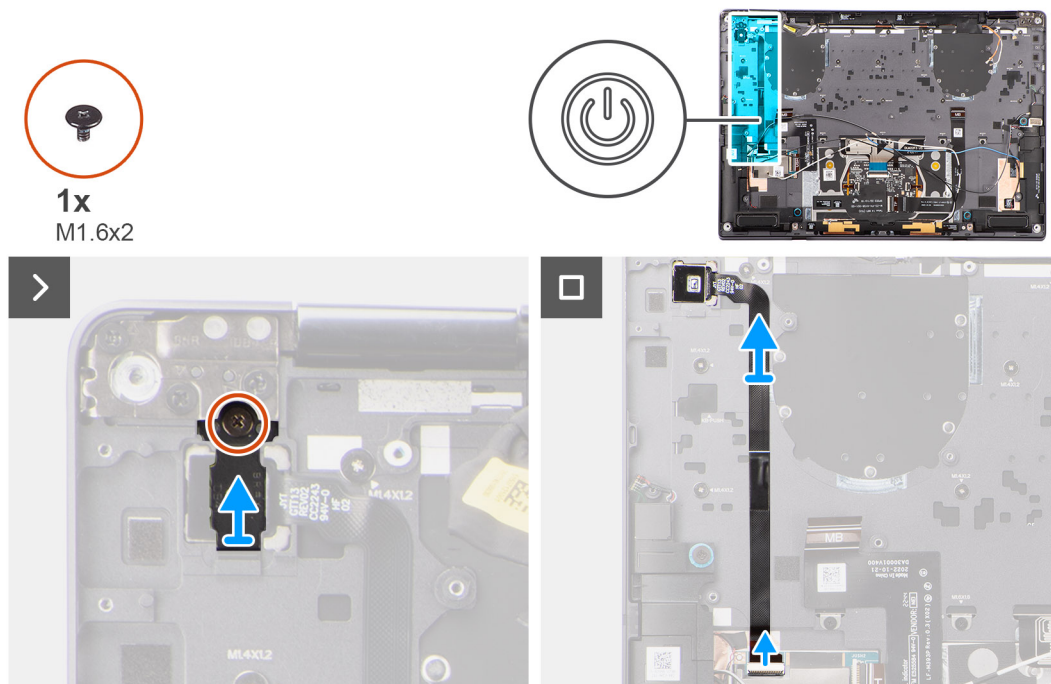

Figure 66. Removing the power button with fingerprint-reader assembly

Steps

1. Remove the single (M1.6x2) screw that secures the power-button bracket in place.
2. Lift the power-button bracket off the computer.
3. For computers shipped with a fingerprint-reader, disconnect the power-button FPC cable from the connector (USH) on the USH I/O board. For computers shipped without a fingerprint-reader, disconnect the power-button FPC cable from the connector on the system board.

NOTE: The power button with fingerprint-reader FPC connects to the USH board and the USH-board FPC cable connects to the system board. The power button without fingerprint-reader FPC connects directly to system board as it uses the same connector as the USH-FPC board connector on the system board.

4. Peel off the power-button FPC cable from the palm-rest and keyboard assembly and lift the power button off the computer.

Installing the power button with fingerprint-reader assembly

CAUTION: The information in this installation section is intended for authorized service technicians only.

Prerequisites

If you are replacing a component, remove the existing component before performing the installation procedure.

About this task

The following image indicates the location of the power button and provides a visual representation of the installation procedure.

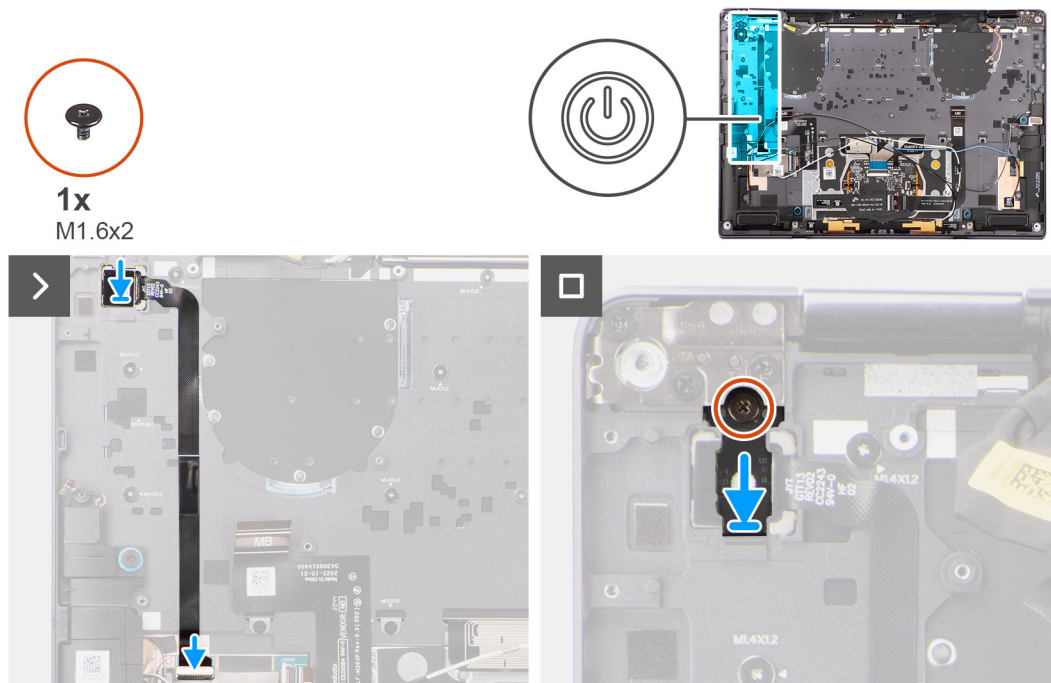

Figure 67. Installing the power button with fingerprint-reader assembly

Steps

1. Align and place the power button on the computer.
2. Adhere the power-button FPC cable on the palm-rest and keyboard assembly.
3. For computers shipped with a fingerprint reader FPC, connect the power button with fingerprint-reader FPC cable to the connector on the USH daughter board. For computers shipped without a fingerprint reader, connect the power-button FPC cable to the connector on the system board.

NOTE: The power button with fingerprint reader FPC connects to the USH board and the USH-board FPC cable connects to the system board. The power button without fingerprint-reader FPC cable connects directly to the system board and it uses the same connector as the USH-board FPC cable connector on the system board.

4. Place the power-button bracket on the power-button assembly.
5. Replace the single (M1.6x2) screw to secure the power-button bracket to the palm-rest and keyboard assembly.

Next steps

1. Install the [system board](#).
2. Install the [battery](#).
3. Install the [heat sink](#).
4. Install the [display assembly](#).
5. Install the [left fan](#).
6. Install the [right fan](#).
7. Install the [WWAN card](#), if applicable.
8. Install the [solid state drive](#).
9. Install the [base cover](#).
10. Install the [nano-SIM card tray](#), if applicable.
11. Follow the procedure in [after working inside your computer](#).

Palm-rest and keyboard assembly

Removing the palm-rest and keyboard assembly

 **CAUTION:** The information in this removal section is intended for authorized service technicians only.

Prerequisites

1. Follow the procedure in [before working inside your computer](#).
2. Remove the [nano-SIM card tray](#), if applicable.
3. Remove the [base cover](#).
4. Remove the [solid state drive](#).
5. Remove the [WWAN card](#), if applicable.
6. Remove the [right fan](#).
7. Remove the [left fan](#).
8. Remove the [display assembly](#).
9. Remove the [heat sink](#).
10. Remove the [battery](#).
11. Remove the [WLAN antenna module](#).
12. Remove the [system board](#).
13. Remove the [right speaker](#).
14. Remove the [power button](#).

About this task

 **NOTE:** For computers shipped without the WLAN card, the left speaker is not a separate replaceable part. The following image indicates the visual representation of keyboard and palm rest assembly of computers that are shipped without WLAN card.

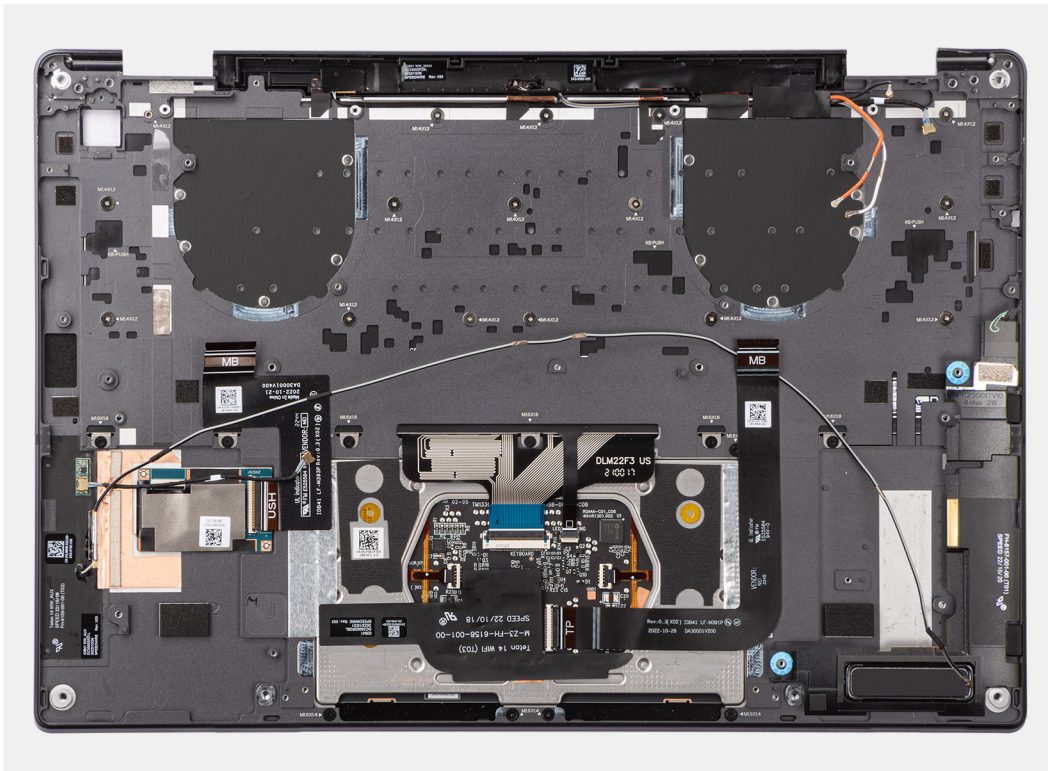

Figure 68. Removing the palm-rest and keyboard assembly

NOTE: The palm-rest and keyboard assembly cannot be further disassembled once all the components that are mentioned in the prerequisites are removed from the chassis. If any components in the palm-rest and keyboard assembly are malfunctioning, replace the entire palm-rest and keyboard assembly.

Installing the palm-rest and keyboard assembly

CAUTION: The information in this installation section is intended for authorized service technicians only.

Prerequisites

If you are replacing a component, remove the existing component before performing the installation procedure.

About this task

NOTE: For computers shipped without the WLAN card, the left speaker is not a separate replaceable part. The following image indicates the visual representation of keyboard and palm rest assembly of computers that are shipped without WLAN card.

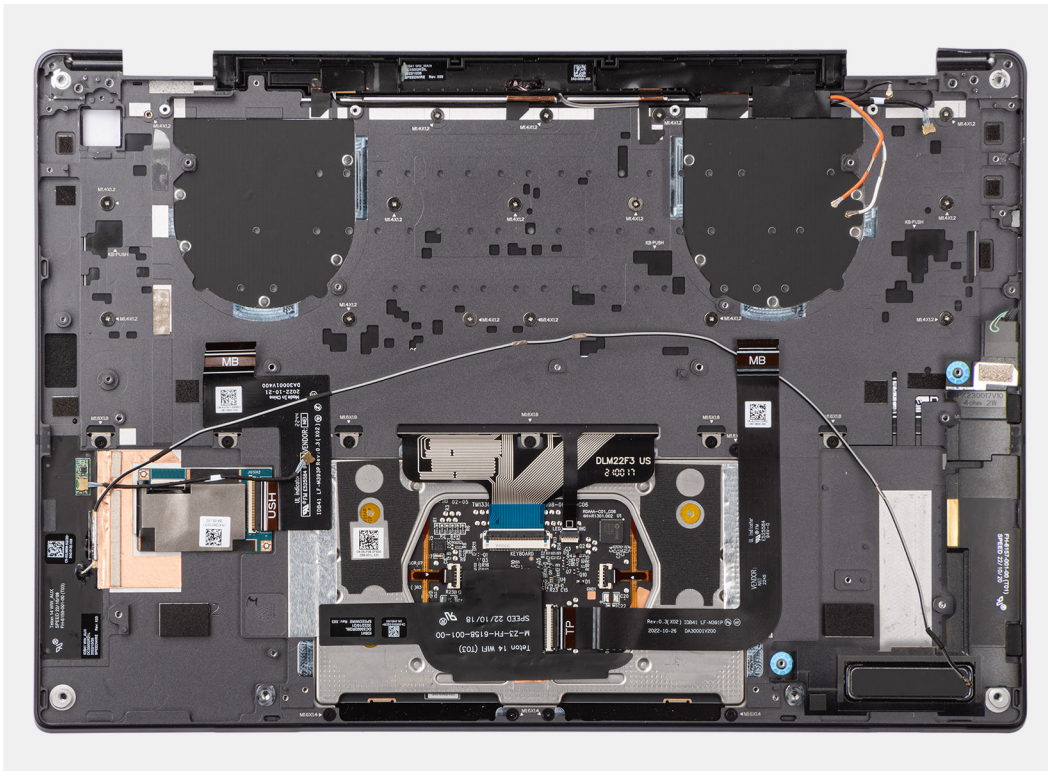

Figure 69. Installing the palm-rest assembly and keyboard assembly

Steps

Place the palm-rest and keyboard assembly on a flat surface.

Next steps

1. Install the [power button](#).
2. Install the [right speaker](#).
3. Install the [system board](#).
4. Install the [WLAN antenna module](#).
5. Install the [battery](#).
6. Install the [heat sink](#).
7. Install the [display assembly](#).
8. Install the [left fan](#).
9. Install the [right fan](#).
10. Install the [WWAN card](#), if applicable.
11. Install the [solid state drive](#).
12. Install the [base cover](#).
13. Install the [nano-SIM card tray](#), if applicable.
14. Follow the procedure in [after working inside your computer](#).

Software

This chapter details the supported operating systems along with instructions on how to install the drivers.

Operating system

Your Latitude 9450 2-in-1 supports the following operating systems:

- Windows 11 22H2
- Windows 11 23H2

Drivers and downloads

When troubleshooting, downloading, or installing drivers, it is recommended that you read the Dell Knowledge Base article Drivers and Downloads FAQs [000123347](#).

BIOS Setup

NOTE: Depending on the computer and the installed devices, the options that are listed in this section may or may not be displayed.

CAUTION: Certain changes can make your computer work incorrectly. Before you change the settings in BIOS Setup, it is recommended that you note down the original settings for future reference.

Use BIOS Setup for the following purposes:

- Get information about the hardware installed in your computer, such as the amount of RAM and the capacity of the storage device.
- Change the system configuration information.
- Set or change a user-selectable option, such as the user password, type of storage device installed, and enable or disable base devices.

Entering BIOS Setup program

About this task

Turn on (or restart) your computer and press F2 immediately.

Navigation keys

NOTE: For most of the BIOS Setup options, changes that you make are recorded but do not take effect until you restart the computer.

Table 29. Navigation keys

Keys	Navigation
Up arrow	Moves to the previous field.
Down arrow	Moves to the next field.
Enter	Selects a value in the selected field (if applicable) or follows the link in the field.
Spacebar	Expands or collapses a drop-down list, if applicable.
Tab	Moves to the next focus area.
Esc	Moves to the previous page until you view the main screen. Pressing Esc in the main screen displays a message that prompts you to save any unsaved changes and restart the computer.

F12 One Time Boot menu

To enter the One Time Boot menu, turn on or restart your computer, and then press F12 immediately.

NOTE: If you are unable to enter the One Time Boot menu, repeat the above action.

The One Time Boot menu displays the devices that you can boot from and also display the options to start diagnostics. The boot menu options are:

- Removable Drive (if available)

- STXXXX Drive (if available)

NOTE: XXX denotes the SATA drive number.

- Optical Drive (if available)
- SATA Hard Drive (if available)
- Diagnostics

The One Time Boot menu screen also displays the option to access BIOS Setup.

View Advanced Setup options

About this task

Some BIOS Setup options are only visible by enabling **Advanced Setup** mode, which is disabled by default.

NOTE: BIOS Setup options, including **Advanced Setup** options, are described in [System setup options](#).

To enable Advanced Setup

Steps

1. Enter BIOS Setup.
The Overview menu appears.
2. Click the **Advanced Setup** option to move it to the **ON** mode.
Advanced BIOS Setup options are visible.

View Service options

About this task

Service options are hidden by default and only visible by entering a hotkey command.

NOTE: Service options are described in [System setup options](#).

To view Service options:

Steps

1. Enter BIOS Setup.
The Overview menu appears.
2. Enter the hotkey combination **Ctrl +Alt + s** to view the **Service** options.
Service options are visible.

System Setup options

NOTE: For most of the System Setup options, changes that you make are recorded but do not take effect until you restart the computer.

NOTE: Depending on your computer and its installed devices, the items that are listed in this section may differ.

Table 30. System Setup options—Overview menu

Overview	
Latitude 9450 2-in-1	
BIOS Version	Displays the BIOS version number.
Service Tag	Displays the Service Tag of the computer.

Table 30. System Setup options—Overview menu (continued)





Overview	
Asset Tag	Displays the Asset Tag of the computer.
Manufacture Date	Displays the manufacture date of the computer.
Ownership Date	Displays the ownership date of the computer.
Express Service Code	Displays the Express Service Code of the computer.
Ownership Tag	Displays the Ownership Tag of the computer.
Signed Firmware Update	Displays whether the Signed Firmware Update is enabled on your computer. By default, the Signed Firmware Update option is enabled.
BATTERY Information	
Primary	Displays the primary battery of the computer.
Battery Level	Displays the battery level of the computer.
Battery State	Displays the battery state of the computer.
Health	Displays the battery health of the computer.
AC Adapter	Displays whether an AC adapter is connected. If connected, displays the type of AC adapter that is connected.
Battery Life Type	Displays battery life as standard, long life cycle 1.0, and long life cycle 2.0. By default, battery life type is set as standard .
PROCESSOR Information	
Processor Type	Displays the processor type.
Maximum Clock Speed	Displays the maximum processor clock speed.  NOTE: To view this option, enable Advanced Setup mode as described in View Advanced Setup options .
Minimum Clock Speed	Displays the minimum processor clock speed.  NOTE: To view this option, enable Advanced Setup mode as described in View Advanced Setup options .
Current Clock Speed	Displays the current processor clock speed.  NOTE: To view this option, enable Advanced Setup mode as described in View Advanced Setup options .
Core Count	Displays the number of cores on the processor.
Processor ID	Displays the processor identification code.
Microcode Version	Displays the microcode version.  NOTE: To view this option, enable Advanced Setup mode as described in View Advanced Setup options .
Intel Hyper-Threading Capable	Displays whether the processor is Hyper-Threading (HT) capable.  NOTE: To view this option, enable Advanced Setup mode as described in View Advanced Setup options .
MEMORY Information	
Memory Installed	Displays the total computer memory installed.
Memory Available	Displays the total computer memory available.
Memory Speed	Displays the memory speed.

Table 30. System Setup options—Overview menu (continued)



Overview	
	<p> NOTE: To view this option, enable Advanced Setup mode as described in View Advanced Setup options.</p>
Memory Channel Mode	<p>Displays single or dual channel mode.</p> <p> NOTE: To view this option, enable Advanced Setup mode as described in View Advanced Setup options.</p>
Memory Technology	Displays the technology that is used for the memory.
DEVICES Information	
Panel Type	Displays the panel type of the computer.
Panel Revision	Displays the panel revision of the computer.
Video Controller	Displays the video controller type of the computer.
Video Memory	Displays the video memory information of the computer.
Wi-Fi Device	Displays the wireless device information of the computer.
Native Resolution	Displays the native resolution of the computer.
Video BIOS Version	<p>Displays the video BIOS version of the computer.</p> <p> NOTE: To view this option, enable Advanced Setup mode as described in View Advanced Setup options.</p>
Audio Controller	Displays the audio controller information of the computer.
Bluetooth Device	Displays the Bluetooth device information of the computer.
Pass Through MAC Address	Displays the MAC address of the video pass-through.
Cellular Device	Displays the Cellular device information of the computer.

Table 31. System Setup options—Boot Configuration menu



Boot Configuration	
Boot Sequence	
Boot Mode: UEFI only	Displays the boot mode of the computer.
Enable PXE Boot Priority	<p>Enables the PXE Boot Priority.</p> <p>By default, the Enable PXE Boot Priority option is disabled.</p>
Secure Boot	
	<p>Secure Boot is a method of guaranteeing the integrity of the boot path by performing additional validation of the operating system and PCI add-in cards. The computer stops booting to the operating system when a component is not authenticated during the boot process. Secure Boot can be enabled in BIOS setup or using management interfaces like Dell Command Configure, but can only be disabled from BIOS setup.</p>
Enable Secure Boot	<p>Enables the computer to boot using only validated boot software.</p> <p>By default, this Enable Secure Boot option is disabled. For additional security, Dell Technologies recommends keeping the Secure Boot option enabled to ensure that the UEFI firmware validates the operating system during the boot process.</p> <p> NOTE: To view this option, enable Advanced Setup mode as described in View Advanced Setup options.</p> <p> NOTE: To enable Secure Boot, the computer is required to be in UEFI boot mode and the Enable Legacy Option ROMs option is required to be turned off.</p>

Table 31. System Setup options—Boot Configuration menu (continued)

Boot Configuration	
Enable Microsoft UEFI CA	<p>When disabled, the UEFI CA is removed from the BIOS UEFI Secure Boot database.</p> <p>NOTE: When disabled, the Microsoft UEFI CA can cause your computer to not boot, computer graphics may not function, some devices may not function properly, and the computer could become unrecoverable.</p> <p>By default, the Enable Microsoft UEFI CA option is enabled.</p> <p>For additional security, Dell Technologies recommends keeping the Microsoft UEFI CA option enabled to ensure the broadest compatibility with devices and operating systems.</p> <p>NOTE: To view this option, enable Advanced Setup mode as described in View Advanced Setup options.</p>
Secure Boot Mode	<p>Enables or disables the Secure Boot operation mode.</p> <p>By default, the Deployed Mode is selected. Deployed Mode should be selected for normal operation of Secure Boot.</p> <p>NOTE: To view this option, enable Advanced Setup mode as described in View Advanced Setup options.</p>
Expert Key Management	
Enable Custom Mode	<p>Enables or disables the keys in the PK, KEK, db, and dbx security key databases to be modified.</p> <p>By default, the Enable Custom Mode option is disabled.</p> <p>NOTE: To view this option, enable Advanced Setup mode as described in View Advanced Setup options.</p>
Custom Mode Key Management	<p>Selects the custom values for expert key management.</p> <p>By default, the PK option is selected.</p> <p>NOTE: To view this option, enable Advanced Setup mode as described in View Advanced Setup options.</p>

Table 32. System Setup options—Integrated Devices menu

Integrated Devices	
Date/Time	
Date	Sets the computer date in MM/DD/YYYY format. Changes to the date format take effect immediately.
Time	Sets the computer time in HH/MM/SS 24-hour format. You can switch between a 12-hour or 24-hour clock. Changes to the time format take effect immediately.
Camera	
Enable Camera	<p>Enables the camera.</p> <p>By default, the Enable Camera option is enabled.</p> <p>NOTE: Depending on the configuration ordered, the camera setup option may not be available.</p>
Audio	
Enable Audio	<p>Enables all integrated audio controller.</p> <p>By default, all the options are enabled.</p>
Enable Microphone	Enables the microphone.

Table 32. System Setup options—Integrated Devices menu (continued)

Integrated Devices	
	<p>By default, the Enable Microphone option is enabled.</p> <p>i NOTE: Depending on the configuration ordered, the microphone setup option may not be available.</p>
Enable Internal Speaker	<p>Enables the internal speaker.</p> <p>By default, the Enable Internal Speaker option is enabled.</p>
USB/Thunderbolt Configuration	
Enable USB Boot Support	<p>Enables booting from USB mass storage devices that are connected to external USB ports.</p> <p>By default, the Enable USB Boot Support option is enabled.</p> <p>i NOTE: To view this option, enable Advanced Setup mode as described in View Advanced Setup options.</p>
Enable External USB Ports	<p>Enables the external USB ports.</p> <p>By default, the Enable External USB Ports option is enabled.</p> <p>i NOTE: To view this option, enable Advanced Setup mode as described in View Advanced Setup options.</p>
Enable Thunderbolt Technology Support	
Enable Thunderbolt Technology Support	<p>Enables the associated ports and adapters for Thunderbolt Technology support.</p> <p>By default, the Enable Thunderbolt Technology Support option is enabled.</p> <p>i NOTE: To view this option, enable Advanced Setup mode as described in View Advanced Setup options.</p>
Enable Thunderbolt Boot Support	
Enable Thunderbolt Boot Support	<p>Enables the Thunderbolt adapter-peripheral device and USB devices that are connected to the Thunderbolt adapter to be used during BIOS Preboot.</p> <p>By default, the Enable Thunderbolt Boot Support option is disabled.</p> <p>i NOTE: To view this option, enable Advanced Setup mode as described in View Advanced Setup options.</p>
Enable Thunderbolt (and PCIe behind TBT) pre-boot modules	<p>Enables the PCIe devices that are connected through a Thunderbolt adapter to run the PCIe devices UEFI Option ROM (if present) during preboot.</p> <p>By default, the Enable Thunderbolt (and PCIe behind TBT) pre-boot modules option is disabled.</p> <p>i NOTE: To view this option, enable Advanced Setup mode as described in View Advanced Setup options.</p>
Disable USB4 PCIE Tunneling	<p>Disables the USB4 PCIE Tunneling option.</p> <p>By default, the Disable USB4 PCIE Tunneling option is disabled.</p> <p>i NOTE: To view this option, enable Advanced Setup mode as described in Entering BIOS Setup program.</p>
Video/Power only on Type-C Ports	<p>Enables or disables the Type-C port functionality to video or only power.</p> <p>By default, the Video/Power only on Type-C Ports option is disabled.</p> <p>i NOTE: To view this option, enable Advanced Setup mode as described in View Advanced Setup options.</p>

Table 32. System Setup options—Integrated Devices menu (continued)

Integrated Devices	
Type-C Dock	
Type-C Dock Override	<p>Enables or disables to use connected Type-C Dell Dock to provide data stream with external USB ports disabled. When Type-C Dock override is enabled, the Video/Audio/LAN submenu is activated.</p> <p>By default, the Type-C Dock Override option is enabled.</p> <p>NOTE: To view this option, enable Advanced Setup mode as described in Entering BIOS Setup program.</p>
Type-C Dock Audio	<p>Enables or disables the usage of audio inputs and outputs from the connected Type-C Dell docking station.</p> <p>By default, the Type-C Dock Audio option is enabled.</p> <p>NOTE: To view this option, enable Advanced Setup mode as described in View Advanced Setup options.</p>
Type-C Dock LAN	<p>Enables or disables the usage of LAN on the external ports of the connected Type-C Dell docking station.</p> <p>By default, the Type-C Dock LAN option is enabled.</p> <p>NOTE: To view this option, enable Advanced Setup mode as described in View Advanced Setup options.</p>
Miscellaneous Devices	
Enable Fingerprint Reader Device	<p>Enables or disables the Fingerprint Reader Device option.</p> <p>By default, the Enable Fingerprint Reader Device option is enabled.</p> <p>NOTE: To view this option, enable Advanced Setup mode as described in View Advanced Setup options.</p>

Table 33. System Setup options—Storage menu

Storage	
SATA/NVMe Operation	
SATA/NVMe Operation	<p>Sets the operating mode of the integrated SATA hard drive controller.</p> <p>By default, the Raid On option is selected.</p>
Storage Interface	
Port Enablement	<p>Enables or disables the M.2 PCIe SSD option.</p> <p>By default, the M.2 PCIe SSD option is enabled.</p>
Smart Reporting	<p>Enables or disables the Smart reporting option.</p> <p>By default, the Smart Reporting option is disabled.</p> <p>NOTE: To view this option, enable Advanced Setup mode as described in View Advanced Setup options.</p>
Drive Information	Displays the information of onboard drives.

Table 34. System Setup options—Display menu

Display	
Display Brightness	
Brightness on battery power	Enables to set the screen brightness when the computer is running on battery power.

Table 34. System Setup options—Display menu (continued)

Display	
	<p>By default, the screen brightness is set to 50 when the computer is running on battery power.</p> <p>i NOTE: To view this option, enable Advanced Setup mode as described in View Advanced Setup options.</p>
Brightness on AC power	<p>Enables to set the screen brightness when the computer is running on AC power. By default, the screen brightness is set to 100 when the computer is running on AC power.</p> <p>i NOTE: To view this option, enable Advanced Setup mode as described in View Advanced Setup options.</p>
Touchscreen	<p>Enables or disables the touch screen option. By default, the Touchscreen option is enabled.</p> <p>i NOTE: Only available on computers with touch screen displays.</p> <p>i NOTE: To view this option, enable Advanced Setup mode as described in View Advanced Setup options.</p>
Full Screen Logo	<p>Enables or disables the computer to display full screen logo, if the image matches screen resolution. By default, the Full Screen Logo option is disabled.</p> <p>i NOTE: To view this option, enable Advanced Setup mode as described in View Advanced Setup options.</p>

Table 35. System Setup options—Connection menu

Connection	
Wireless Device Enable	
WWAN/GPS	<p>Enables or disables the internal WWAN device. By default, the WWAN/GPS option is enabled.</p>
WLAN	<p>Enables or disables the internal WLAN device. By default, the WLAN option is enabled.</p>
Bluetooth	<p>Enables or disables the internal Bluetooth device. By default, the Bluetooth option is enabled.</p>
Enable UEFI Network Stack	<p>Enables or disables the UEFI Network Stack and controls the onboard LAN Controller. By default, the Enable UEFI Network Stack option is enabled.</p> <p>i NOTE: To view this option, enable Advanced Setup mode as described in View Advanced Setup options.</p>
Wireless Radio Control	
Control WLAN Radio	<p>Enables to sense the connection of the computer to a wired network and then disables the selected WLAN radio. Upon disconnection from the wired network, the selected wireless radios are reenabled. By default, the Control WLAN Radio option is disabled.</p> <p>i NOTE: To view this option, enable Advanced Setup mode as described in View Advanced Setup options.</p>

Table 35. System Setup options—Connection menu (continued)

Connection	
Control WWAN Radio	<p>Enables to sense the connection of the computer to a wired network and then disables the selected WWAN radios.</p> <p>By default, the Control WWAN Radio option is disabled.</p> <p>NOTE: To view this option, enable Advanced Setup mode as described in View Advanced Setup options.</p>
Enable UEFI Bluetooth Stack	<p>Enables or disables the UEFI Bluetooth Stack and controls the onboard LAN Controller.</p> <p>By default, the Enable UEFI Bluetooth Stack option is enabled.</p> <p>NOTE: To view this option, enable Advanced Setup mode as described in View Advanced Setup options.</p>
Dynamic Wireless Transmit Power	<p>When enabled, the computer increases the transmit power of the WLAN device to improve performance in certain computer configurations.</p> <p>By default, the Dynamic Wireless Transmit Power is disabled.</p> <p>NOTE: To view this option, enable Advanced Setup mode as described in View Advanced Setup options.</p>
HTTP(s) Boot	<p>When enabled, supports HTTP(s) boot on the client BIOS, which offers wired or wireless and HTTP/HTTPS connection options.</p> <p>NOTE: To view this option, enable HTTP(s) Boot as described in View Advanced Setup options.</p>
HTTP(s) Boot Modes	<p>In Auto Mode, the boot URL is obtained from the DHCP response; the boot URL specifies the HTTP Boot Server and location of the Network Boot Program (NBP) file. In Manual mode, the user enters the URL in the text box, which must start with <code>http://</code> or <code>https://</code> and end with the NBP file name.</p> <p>By default, the Control WWAN Radio option is disabled.</p> <p>By default, Auto Mode is selected.</p> <p>NOTE: To view this option, enable Advanced Setup mode as described in View Advanced Setup options.</p>

Table 36. System Setup options—Power menu

Power	
Battery Configuration	<p>Enables or disables the computer to run on battery during peak power usage hours. Use the table Custom Charge Start and Custom Charge Stop, to prevent AC power usage between certain times of each day.</p> <p>By default, the Adaptive option is selected. Battery settings are adaptively optimized based on your typical battery usage pattern.</p>
Advanced Configuration	<p>Enable Advanced Battery Charge Configuration</p> <p>Enables Advanced Battery Charge Configuration from the beginning of the day to a specified work period. When enabled, Advanced Battery Charged maximizes battery health while still supporting heavy use during the work day.</p> <p>By default, the Enable Advanced Battery Charge Configuration option is disabled.</p> <p>NOTE: To view this option, enable Advanced Setup mode as described in View Advanced Setup options.</p>
Peak Shift	<p>Enable Peak Shift</p> <p>Enables or disables the computer to run on battery during peak power usage hours.</p>

Table 36. System Setup options—Power menu (continued)

Power	
	<p>By default, the Enable Peak Shift option is disabled.</p> <p>i NOTE: To view this option, enable Advanced Setup mode as described in View Advanced Setup options.</p>
Thermal Management	<p>Enables or disables cooling of the fan and manages the processor heat to adjust the system performance, noise, and temperature.</p> <p>By default, the Optimized option is selected. Standard settings for balanced performance, noise, and temperature.</p>
USB Wake Support	
Wake on Dell USB-C Dock	<p>When enabled, connecting a Dell USB-C Dock wakes the computer from Standby, Hibernate, and Power Off.</p> <p>By default, the Wake on Dell USB-C Dock option is enabled.</p> <p>i NOTE: To view this option, enable Advanced Setup mode as described in View Advanced Setup options.</p>
Block Sleep	<p>Enables or disables the computer from entering Sleep (S3) mode in the operating system.</p> <p>By default, the Block Sleep option is disabled.</p> <p>i NOTE: When enabled, the computer does not go to Sleep, Intel Rapid Start is disabled automatically, and the operating system power option is blank if it was set to Sleep.</p> <p>i NOTE: To view this option, enable Advanced Setup mode as described in View Advanced Setup options.</p>
Lid Switch	
Enable Lid Switch	<p>Enables or disables the Lid Switch.</p> <p>By default, the Enable Lid Switch option is enabled.</p>
Power On Lid Open	<p>When enabled, allows the computer to turn on from the off state whenever the lid is opened.</p> <p>By default, the Power On Lid Open option is enabled.</p>
Intel Speed Shift Technology	<p>Enables or disables the Intel Speed Shift Technology support. When enabled, the operating system selects the appropriate processor performance automatically.</p> <p>By default, the Intel Speed Shift Technology option is enabled.</p> <p>i NOTE: To view this option, enable Service options as described in View Service options.</p>

Table 37. System Setup options—Security menu

Security	
TPM 2.0 Security	<p>Trusted Platform Module (TPM) is a security device that stores computer-generated keys for encryption and features such as BitLocker, Virtual Secure Mode, remote Attestation.</p> <p>By default, the TPM 2.0 Security option is enabled.</p> <p>For additional security, Dell Technologies recommends keeping the Trusted Platform Module (TPM) enabled to allow these security technologies to fully function.</p>
TPM 2.0 Security On	<p>Enables or disables the TPM.</p> <p>By default, the TPM 2.0 Security On option is enabled.</p>

Table 37. System Setup options—Security menu (continued)

Security	
	<p>For additional security, Dell Technologies recommends keeping TPM enabled to allow these security technologies to fully function.</p> <p>NOTE: To view this option, enable Advanced Setup mode as described in View Advanced Setup options.</p>
Attestation Enable	<p>The Attestation Enable option controls the endorsement hierarchy of TPM. Disabling the Attestation Enable option prevents TPM from being used to digitally sign certificates.</p> <p>By default, the Attestation Enable option is enabled.</p> <p>For additional security, Dell Technologies recommends keeping the Attestation Enable option enabled.</p> <p>NOTE: When disabled, this feature may cause compatibility issues or loss of functionality in some operating systems.</p> <p>NOTE: To view this option, enable Advanced Setup mode as described in View Advanced Setup options.</p>
Key Storage Enable	<p>The Key Storage Enable option controls the storage hierarchy of TPM, which is used to store digital keys. Disabling the Key Storage Enable option restricts the ability of TPM to store owner's data.</p> <p>By default, the Key Storage Enable option is enabled.</p> <p>For additional security, Dell Technologies recommends keeping the Key Storage Enable option enabled.</p> <p>NOTE: When disabled, this feature may cause compatibility issues or loss of functionality in some operating systems.</p> <p>NOTE: To view this option, enable Service options as described in View Service options.</p>
Clear	<p>When enabled, the Clear option clears information that is stored in the TPM after exiting the system's BIOS. This option returns to the disabled state when the computer restarts.</p> <p>By default, the Clear option is disabled.</p> <p>Dell Technologies recommends enabling the Clear option only when TPM data is required to be cleared.</p> <p>NOTE: To view this option, enable Advanced Setup mode as described in View Advanced Setup options.</p>
Physical Presence Interface (PPI) Bypass for Clear Commands	<p>The PPI Bypass for Clear Commands option allows the operating system to manage certain aspects of PTT. When enabled, you are not prompted to confirm changes to the PTT configuration.</p> <p>By default, the PPI Bypass for Clear Commands option is disabled.</p> <p>For additional security, Dell Technologies recommends keeping the PPI Bypass for Clear Commands option disabled.</p>
Intel Total Memory Encryption	<p>Enables or disables the processor's memory encryption feature.</p> <p>By default, the Intel Total Memory Encryption option is disabled.</p> <p>NOTE: To view this option, enable Advanced Setup mode as described in View Advanced Setup options.</p>
Chassis Intrusion	
Chassis Intrusion	<p>Enables or disables the detection of chassis intrusion events. This feature notifies the user when the base cover has been removed from the computer.</p>

Table 37. System Setup options—Security menu (continued)







Security	
	<p>When set to Enabled, a notification is displayed on the next boot and the event is logged in the BIOS Events log.</p> <p>When set to Disabled, no notification is displayed and no event is logged in the BIOS Events log.</p> <p>When set to On-Silent, the event is logged in the BIOS Events log, but no notification is displayed.</p> <p>By default, the Chassis Intrusion Detection option is disabled.</p> <p>For additional security, Dell Technologies recommends keeping the Chassis Intrusion option enabled.</p> <p> NOTE: To view this option, enable Advanced Setup mode as described in View Advanced Setup options.</p>
Block Boot Until Cleared	<p>The Block Boot Until Clear option is enabled when Chassis Intrusion is enabled. When enabled, the computer does not boot until the chassis intrusion is cleared.</p> <p>By default, the Block Boot Until Clear option is disabled.</p> <p> NOTE: To view this option, enable Advanced Setup mode as described in View Advanced Setup options.</p>
Clear Intrusion Warning	<p>Clear Intrusion Warning appears only after chassis intrusion is enabled and has been tripped.</p> <p>By default, the Clear Intrusion Warning option is disabled.</p> <p> NOTE: To view this option, enable Advanced Setup mode as described in View Advanced Setup options.</p>
SMM Security Mitigation	<p>Enables or disables additional UEFI SMM Security Mitigation protections. This option uses the Windows SMM Security Mitigations Table (WSMT) to confirm to the operating system that security best practices have been implemented by the UEFI firmware.</p> <p>By default, the SMM Security Mitigation option is enabled.</p> <p>For additional security, Dell Technologies recommends keeping the SMM Security Mitigation option enabled unless you have a specific application which is not compatible.</p> <p> NOTE: This feature may cause compatibility issues or loss of functionality with some legacy tools and applications.</p> <p> NOTE: To view this option, enable Service options as described in View Service options.</p>
Data Wipe on Next Boot	
Start Data Wipe	<p>Data Wipe is a secure wipe operation that deletes information from a storage device.</p> <p> CAUTION: The Secure Data Wipe operation erases information in a way that it cannot be reconstructed.</p> <p>Commands such as delete and format in the operating system may remove files from showing up in the file system, however they can be reconstructed through forensic means as they are still represented on the physical media. Data Wipe prevents this reconstruction and is not recoverable.</p> <p>When enabled, the BIOS will queue up a data wipe cycle for storage devices that are connected to the motherboard on the next reboot.</p> <p>By default, the Start Data Wipe option is disabled.</p>

Table 37. System Setup options—Security menu (continued)







Security	
	<p> NOTE: To view this option, enable Advanced Setup mode as described in View Advanced Setup options.</p>
HDD Security	
SED Block SID Authentication	<p>Allows you to enable SED Block SID Authentication.</p> <p>By default, the SED Block SID Authentication option is enabled.</p>
PPI Bypass for SED Block SID Command	<p>Allows you to enable PPI Bypass for SED Block SID Command.</p> <p>By default, the PPI Bypass for SED Block SID Command option is disabled.</p>
Absolute	<p>Absolute Software provides various cyber security solutions, some requiring software preloaded on Dell computers and integrated into the BIOS. To use these features, you must enable the Absolute BIOS setting and contact Absolute for configuration and activation.</p> <p>By default, the Absolute option is enabled.</p> <p>For additional security, Dell Technologies recommends keeping the Absolute option enabled.</p> <p> WARNING: The Permanently Disabled option can only be selected once. When Permanently Disabled is selected, Absolute Persistence cannot be reenabled. No further changes to the Enable/Disable states are allowed.</p> <p> NOTE: The Enable/Disable options are unavailable while the computer is in the activated state.</p> <p> NOTE: When the Absolute features are activated, the Absolute integration cannot be disabled from the BIOS Setup screen.</p>
UEFI Boot Path Security	<p>Enables or disables the computer to prompt the user to enter the Administrator password (if set) when booting to a UEFI boot path device from the F12 boot menu.</p> <p>By default, the Always Except Internal HDD option is enabled.</p> <p> NOTE: To view this option, enable Advanced Setup mode as described in View Advanced Setup options.</p>
Firmware Device Tamper Detection	<p>Allows you to control the firmware device tamper detection feature. This feature notifies the user when the firmware device is tampered. When enabled, a screen warning message is displayed on the computer and a tamper detection event is logged in the BIOS Events log. The computer fails to reboot until the event is cleared.</p> <p>By default, the Firmware Device Tamper Detection option is enabled.</p> <p>For additional security, Dell Technologies recommends keeping the Firmware Device Tamper Detection option enabled.</p> <p> NOTE: To view this option, enable Advanced Setup mode as described in View Advanced Setup options.</p>
SafeShutter	
Dynamic Shutter	<p>Device camera shutter will automatically open when user grants application permission and closes when permission ends. Disable dynamic behavior by pressing F9 camera mute (LED on).</p> <p>By default, the Dynamic Shutter option is disabled.</p>
Manual Shutter Control	<p>Manual Shutter Control</p> <p>Disengage camera off by pressing F9 to open shutter (LED off).</p>

Table 37. System Setup options—Security menu (continued)





Security	
	Engage camera on by pressing F9 to close shutter (LED on). By default, the Manual Shutter Control option is enabled.
Firmware Device Tamper Detection	The field controls the Firmware Device Temper Detection feature. By default, the Firmware Device Tamper Detection set to silent.  NOTE: To view this option, enable Advanced Setup mode as described in View Advanced Setup options .
Clear Firmware Device Tamper Detection	Select this option to clear the event and allow booting. By default, the Clear Firmware Device Tamper Detection option is disabled.  NOTE: To view this option, enable Advanced Setup mode as described in View Advanced Setup options .
Intel Platform Trust Technology	
PPI Bypass for Clear Commands	By default, the PPI Bypass for Clear Commands option is disabled.  NOTE: To view this option, enable Advanced Setup mode as described in View Advanced Setup options .
Intel Platform Trust Technology On	By default, the Intel Platform Trust Technology On option is enabled.  NOTE: To view this option, enable Advanced Setup mode as described in View Advanced Setup options .
Clear	By default, the Clear option is disabled.  NOTE: To view this option, enable Advanced Setup mode as described in View Advanced Setup options .

Table 38. System Setup options—Passwords menu

Passwords	
Administrator Password	The Administrator Password prevents unauthorized access to the BIOS Setup options. Once the administrator password is set, the BIOS Setup options can only be modified after providing the correct password. The following rules and dependencies apply to the Administrator Password - <ul style="list-style-type: none"> • The administrator password cannot be set if system and/or internal hard drive passwords are previously set. • The administrator password can be used in place of the system and/or internal hard drive passwords. • When set, the administrator password must be provided during a firmware update. • Clearing the administrator password also clears the system password (if set). Dell Technologies recommends using an administrator password to prevent unauthorized changes to BIOS Setup options.
System Password	The System Password prevents the computer from booting to an operating system without entering the correct password. The following rules and dependencies apply when the System Password is used - <ul style="list-style-type: none"> • The computer shuts down when idle for approximately 10 minutes at the system password prompt. • The computer shuts down after three incorrect attempts to enter the system password.

Table 38. System Setup options—Passwords menu (continued)

<p>Passwords</p>	<ul style="list-style-type: none"> • The computer shuts down when the Esc key is pressed at the System Password prompt. • The system password is not prompted when the computer resumes from standby mode. <p>Dell Technologies recommends using the system password in situations where it is likely that a computer may be lost or stolen.</p>
<p>Hard Drive Password</p> <p>i NOTE: On some computers, the M.2 PCIe SSD-0 Password option is shown.</p>	<p>The hard drive password can be set to prevent unauthorized access of the data stored on the solid state drive. The computer prompts for the hard drive password during boot in order to unlock the drive. A password-secured hard drive stays locked even when removed from the computer or placed into another computer. It prevents an attacker from accessing data on the drive without authorization.</p> <p>The following rules and dependencies apply when the Hard Drive Password or M.2 PCIe SSD-0 Password option is used.</p> <ul style="list-style-type: none"> • The hard drive password option cannot be accessed when the hard drive is disabled in the BIOS Setup. • The computer shuts down when idle for approximately 10 minutes at the hard drive password prompt. • The computer shuts down after three incorrect attempts to enter the hard drive password and treats the hard drive as not available. • The hard drive does not accept password unlock attempts after five incorrect attempts to enter the hard drive password from the BIOS Setup. The hard drive password must be reset for the new password unlock attempts. • The computer treats the hard drive as not available when the Esc key is pressed at the hard drive password prompt. • The hard drive password is not prompted when the computer resumes from standby mode. When the hard drive is unlocked by the user before the computer goes into standby mode, it remains unlocked after the computer resumes from standby mode. • If the system and hard drive passwords are set to the same value, the hard drive unlocks after the correct system password is entered. <p>Dell Technologies recommends using a hard drive password to protect unauthorized data access.</p>
<p>Password Configuration</p>	<p>The Password configuration page includes several options for changing the requirements of BIOS passwords. You can modify the minimum and maximum length of the passwords as well as require passwords to contain certain character classes (upper case, lower case, digit, special character).</p> <p>When the Lower Case Letter option is enabled, the password requires at least one lower case letter.</p> <p>When the Upper Case Letter option is enabled, the password requires at least one upper case letter.</p> <p>When the Digit option is enabled, the password requires at least one numeric digit.</p> <p>When the Special Character option is enabled, the password requires at least one special character from the set: !"#\$\$%&'()*+,-./:;<=>?@[\\]^_`{ }~.</p> <p>When setting Minimum Characters for password length, Dell Technologies recommends setting the minimum password length to at least eight characters.</p> <p>i NOTE: To view this option, enable Advanced Setup mode as described in View Advanced Setup options.</p>
<p>Password Bypass</p>	<p>The Password Bypass option allows the computer to reboot from the operating system without entering the system or hard drive password. If the computer has</p>

Table 38. System Setup options—Passwords menu (continued)

Passwords	
	<p>already booted to the operating system, it is presumed that the user has already entered the correct system or hard drive password.</p> <p>i NOTE: This option does not remove the requirement to enter the password after shutting down.</p> <p>By default, the Password Bypass option is disabled.</p> <p>For additional security, Dell Technologies recommends keeping the Password Bypass option enabled.</p> <p>i NOTE: To view this option, enable Advanced Setup mode as described in View Advanced Setup options.</p>
Password Changes	
Allow Non-Admin Password Changes	<p>The Allow Non-Admin Password Changes option in BIOS Setup allows an end user to set or change the system or hard drive passwords without entering the administrator password. This gives an administrator control over the BIOS settings but enables an end user to provide their own password.</p> <p>By default, the Allow Non-Admin Password Changes option is enabled.</p> <p>For additional security, Dell Technologies recommends keeping the Allow Non-Admin Password Changes option disabled.</p> <p>i NOTE: To view this option, enable Advanced Setup mode as described in View Advanced Setup options.</p>
Enable Admin Setup Lockout	<p>The Admin Setup Lockout option prevents an end user from even viewing the BIOS Setup configuration without first entering the administrator password (if set).</p> <p>By default, the Enable Admin Setup Lockout option is disabled.</p> <p>For additional security, Dell Technologies recommends keeping the Admin Setup Lockout option disabled.</p> <p>i NOTE: To view this option, enable Advanced Setup mode as described in View Advanced Setup options.</p>
Enable Master Password Lockout	<p>The Master Password Lockout option allows you to disable the Recovery Password feature. If the system, administrator, or hard drive password is forgotten, the computer becomes unusable.</p> <p>i NOTE: When the owner password is set, the Master Password Lockout option is not available.</p> <p>i NOTE: When an internal hard drive password is set, it must first be cleared before Master Password Lockout can be changed.</p> <p>By default, the Enable Master Password Lockout option is disabled.</p> <p>Dell Technologies does not recommend enabling the Master Password Lockout unless you have implemented your own password recovery system.</p> <p>i NOTE: To view this option, enable Advanced Setup mode as described in View Advanced Setup options.</p>
Enable Allow Non-Admin PSID Revert	<p>The Allow Non-Admin PSID Revert option allows a user to clear the hard drive password without entering the BIOS Admin Password. When an Admin Password is set, the ability to enter the PSID is protected by requiring authentication with the Admin Password. If this option is enabled, any user can clear the drive without entering the Admin Password.</p> <p>By default, the Enable Allow Non-Admin PSID Revert option is disabled.</p> <p>i NOTE: To view this option, enable Advanced Setup mode as described in View Advanced Setup options.</p>

Table 39. System Setup options—Update, Recovery menu

Update, Recovery	
UEFI Capsule Firmware Updates	
Enable UEFI Capsule Firmware Updates	<p>Enables or disables BIOS updates through UEFI capsule update packages.</p> <p>NOTE: Disabling this option blocks the BIOS updates from services such as Microsoft Windows Update and Linux Vendor Firmware Service (LVFS).</p> <p>By default, the Enable UEFI Capsule Firmware Updates option is enabled.</p> <p>NOTE: To view this option, enable Advanced Setup mode as described in View Advanced Setup options.</p>
BIOS Recovery from Hard Drive	
	<p>Enables or disables the user to recover from certain corrupted BIOS conditions from a recovery file on the user primary hard drive or an external USB drive.</p> <p>By default, the BIOS Recovery from Hard Drive option is enabled.</p> <p>NOTE: BIOS Recovery from Hard Drive is not available for self-encrypting drives (SED).</p> <p>NOTE: BIOS recovery is designed to fix the main BIOS block and cannot work if the Boot Block is damaged. In addition, this feature cannot work in the event of EC corruption, ME corruption, or a hardware issue. The recovery image must exist on an unencrypted partition on the drive.</p> <p>NOTE: To view this option, enable Advanced Setup mode as described in View Advanced Setup options.</p>
BIOS Downgrade	
Allow BIOS Downgrade	<p>Allows downgrading of the system firmware to previous revisions.</p> <p>By default, the Allow BIOS Downgrade option is enabled.</p>
SupportAssist OS Recovery	
	<p>Enables or disables the boot flow for SupportAssist OS Recovery tool if certain system errors occur.</p> <p>By default, the SupportAssist OS Recovery option is enabled.</p>
BIOSConnect	
	<p>Enables or disables cloud service operating system recovery if the main operating system fails to boot with the number of failures equal to or greater than the value specified by the Auto operating system Recovery Threshold setup option and local service operating system does not boot or is not installed.</p> <p>By default, the BIOSConnect option is enabled.</p>
Dell Auto OS Recovery Threshold	
	<p>Allows the control of the automatic boot flow for the SupportAssist System Resolution Console and the Dell operating system Recovery Tool.</p> <p>By default, the Dell Auto OS Recovery Threshold value is set to 2.</p> <p>NOTE: To view this option, enable Advanced Setup mode as described in View Advanced Setup options.</p>

Table 40. System Setup options—System Management menu

System Management	
Service Tag	Displays the Service Tag of the computer.
Asset Tag	<p>Creates a computer Asset Tag that an IT administrator can use to uniquely identify a particular computer.</p> <p>NOTE: Once set in the BIOS, the Asset Tag cannot be changed.</p>
Wake on AC	<p>Enables or disables the computer to turn on and go to boot when AC power is supplied to the computer.</p> <p>By default, the Wake on AC option is disabled.</p>

Table 40. System Setup options—System Management menu (continued)







System Management	
	<p> NOTE: To view this option, enable Advanced Setup mode as described in View Advanced Setup options.</p>
Wake on LAN	<p>Enables or disables the computer to turn on by a special LAN signal.</p> <p>By default, the Wake on LAN option is disabled.</p> <p> NOTE: To view this option, enable Advanced Setup mode as described in View Advanced Setup options.</p>
Auto On Time	<p>Enable to set the computer to turn on automatically every day or on a preselected date and time. This option can be configured only if the Auto On Time is set to Everyday, Weekdays, or Selected Days.</p> <p>By default, the Auto On Time option is disabled.</p> <p> NOTE: To view this option, enable Advanced Setup mode as described in View Advanced Setup options.</p>
Intel AMT capability	<p>Configure Intel Active Management Technology (AMT) options, which can be enabled, disabled, or restricted.</p> <p> NOTE: To view this option, enable Advanced Setup mode as described in View Advanced Setup options.</p>
Diagnostics OS agent requests	<p>Enable or disable the option for applications running in the operating system to run with preboot diagnostics on subsequent boots.</p> <p> NOTE: To view this option, enable Advanced Setup mode as described in View Advanced Setup options.</p>
First Power On Date	<p>Allows you to set ownership date.</p> <p>By default, the First Power On Date option is disabled.</p>
Power-On-Self-Test Automatic Recovery	<p>Enable or disable the automatic recovery of the computer from no power or no-POST failure by applying mitigation steps.</p> <p>By default, the Power-On-Self-Test Automatic Recovery option is enabled.</p> <p> NOTE: To view this option, enable Advanced Setup mode as described in View Advanced Setup options.</p>

Table 41. System Setup options—Keyboard menu

Keyboard	
Fn Lock Options	<p>Enables or disables the Fn Lock option.</p> <p>By default, the Fn Lock option is enabled.</p>
Lock Mode	<p>By default, the Lock Mode Secondary option is enabled. With this option, the F1-F12 keys scan the code for their secondary functions.</p>
Keyboard Illumination	<p>Configures the operating mode of the keyboard illumination feature.</p> <p>By default, the Dim option is selected. Enables the keyboard illumination feature at 100% brightness level.</p>
Keyboard Backlight Timeout on AC	<p>Sets the timeout value for the keyboard backlight when an AC adapter is connected to the computer.</p> <p>By default, the 10 seconds option is selected.</p> <p> NOTE: To view this option, enable Advanced Setup mode as described in View Advanced Setup options.</p>

Table 41. System Setup options—Keyboard menu (continued)

Keyboard	
Keyboard Backlight Timeout on Battery	<p>Sets the timeout value for the keyboard backlight when the computer is running only on the battery power. The keyboard backlight timeout value is only effective when the backlight is enabled.</p> <p>By default, the 10 seconds option is selected.</p> <p>i NOTE: To view this option, enable Advanced Setup mode as described in View Advanced Setup options.</p>
Device Configuration HotKey Access	<p>Allows you to control whether you can access device configuration screens through hotkeys during system startup.</p> <p>By default, the Device Configuration HotKey Access option is enabled.</p> <p>i NOTE: This setting controls only the Intel RAID (CTRL+I), MEBX (CTRL+P), and LSI RAID (CTRL+C) Option ROMs. Other preboot Option ROMs, which support entry using a key sequence, are not affected by this setting.</p> <p>i NOTE: To view this option, enable Advanced Setup mode as described in View Advanced Setup options.</p>

Table 42. System Setup options—Pre-boot Behavior menu

Pre-boot Behavior	
Adapter Warnings	
Enable Dock Warning Messages	<p>Enables the warning messages during boot when the adapters with less power capacity are detected.</p> <p>By default, the Enable Dock Warning Messages option is enabled.</p> <p>i NOTE: To view this option, enable Advanced Setup mode as described in View Advanced Setup options.</p>
Warnings and Errors	<p>Enables or disables the action to be taken when a warning or error is encountered.</p> <p>By default, the Prompt on Warnings and Errors option is selected. Stop, prompt, and wait for user input when warnings or errors are detected.</p> <p>i NOTE: Errors deemed critical to the operation of the computer hardware stop the functioning of the computer.</p> <p>i NOTE: To view this option, enable Advanced Setup mode as described in View Advanced Setup options.</p>
Extend BIOS POST Time	<p>Sets the BIOS POST (Power-On Self-Test) load time.</p> <p>By default, the 0 seconds option is selected.</p> <p>i NOTE: To view this option, enable Advanced Setup mode as described in View Advanced Setup options.</p>
MAC Address Pass-Through	<p>Replaces the external NIC MAC address (in a supported dock or dongle) with the selected MAC address from the computer.</p> <p>By default, the System Unique MAC Address option is selected.</p>
Sign of Life	
Early Logo Display	<p>Displays the Logo Sign of Life.</p> <p>By default, the Early Logo Display option is enabled.</p> <p>i NOTE: To view this option, enable Advanced Setup mode as described in View Advanced Setup options.</p>
Early Keyboard Backlight	<p>Enables or disables the Keyboard Backlight Sign of Life.</p>

Table 42. System Setup options—Pre-boot Behavior menu (continued)

Pre-boot Behavior	
	<p>By default, the Early Keyboard Backlight option is enabled.</p> <p>i NOTE: To view this option, enable Advanced Setup mode as described in View Advanced Setup options.</p>
Collaboration Touchpad	<p>This field allows you to enable the collaboration features of the Collaboration Touchpad.</p> <p>By default, the Collaboration Touchpad option is enabled.</p>

Table 43. System Setup options—Virtualization menu

Virtualization Support	
Intel Virtualization Technology	
Enable Intel Virtualization Technology (VT)	<p>When enabled, the computer can run a Virtual Machine Monitor (VMM).</p> <p>By default, the Enable Intel Virtualization Technology (VT) option is enabled.</p> <p>i NOTE: To view this option, enable Advanced Setup mode as described in View Advanced Setup options.</p>
VT for Direct I/O	
Enable Intel VT for Direct I/O	<p>When enabled, the computer can perform Virtualization Technology for Direct I/O (VT-d). VT-d is an Intel method that provides virtualization for memory map I/O.</p> <p>By default, the Enable Intel VT for Direct I/O option is enabled.</p> <p>i NOTE: To view this option, enable Advanced Setup mode as described in View Advanced Setup options.</p>
Intel Trusted Execution Technology (TXT)	<p>Specifies whether a measured Virtual Machine Monitor (MVMM) can use the additional hardware capabilities provided by Intel Trusted Execution Technology. The following must be enabled in order to enable Intel TXT -</p> <ul style="list-style-type: none"> ● Trusted Platform Module (TPM) ● Intel Hyper-Threading ● All CPU cores (Multi-Core Support) ● Intel Virtualization Technology ● Intel VT for Direct I/O <p>By default, the Intel Trusted Execution Technology (TXT) option is disabled.</p> <p>i NOTE: To view this option, enable Advanced Setup mode as described in View Advanced Setup options.</p>
DMA Protection	
Enable Pre-Boot DMA Support	<p>Allows you to control the Pre-Boot DMA protection for both internal and external ports. This option does not directly enable DMA protection in the operating system.</p> <p>i NOTE: This option is not available when the virtualization setting for IOMMU is disabled (VT-d/AMD Vi).</p> <p>By default, the Enable Pre-Boot DMA Support option is enabled.</p> <p>For additional security, Dell Technologies recommends keeping the Enable Pre-Boot DMA Support option enabled.</p> <p>i NOTE: This option is provided only for compatibility purposes, since some older hardware is not DMA capable.</p> <p>i NOTE: To view this option, enable Advanced Setup mode as described in View Advanced Setup options.</p>

Table 43. System Setup options—Virtualization menu (continued)

Virtualization Support	
Enable OS Kernel DMA Support	<p>Allows you to control the Kernel DMA protection for both internal and external ports. This option does not directly enable DMA protection in the operating system. For operating systems that support DMA protection, this setting indicates to the operating system that the BIOS supports the feature.</p> <p>NOTE: This option is not available when the virtualization setting for IOMMU is disabled (VT-d/AMD Vi).</p> <p>By default, the Enable OS Kernel DMA Support option is enabled.</p> <p>NOTE: This option is provided only for compatibility purposes, since some older hardware is not DMA capable.</p> <p>NOTE: To view this option, enable Advanced Setup mode as described in View Advanced Setup options.</p>
Internal Port DMA Compatibility Mode	<p>Allows you to control the Internal Port DMA Compatibility for both internal and external ports.</p> <p>By default, the Internal Port DMA Compatibility Mode option is disabled.</p> <p>NOTE: To view this option, enable Advanced Setup mode as described in View Advanced Setup options.</p>

Table 44. System Setup options—Performance menu

Performance	
Multi-Core Support	
Multiple Atom Cores	<p>Change the number of Atom cores available to the operating system. The default value is set to the maximum number of cores.</p> <p>By default, the All Cores option is selected.</p> <p>NOTE: To view this option, enable Advanced Setup mode as described in View Advanced Setup options.</p>
Intel SpeedStep	
Enable Intel SpeedStep Technology	<p>Enables the computer to dynamically adjust processor voltage and core frequency, decreasing average power consumption and heat production.</p> <p>By default, the Enable Intel SpeedStep Technology option is enabled.</p> <p>NOTE: To view this option, enable Service options as described in View Service options.</p>
C-State Control	
Enable C-State Control	<p>Enables or disables the ability of the CPU to enter and exit low-power state. When disabled, it disables all C-states. When enabled, it enables all C-states that the chipset or platform allows.</p> <p>By default, the Enable C-State Control option is enabled.</p> <p>NOTE: To view this option, enable Advanced Setup mode as described in View Advanced Setup options.</p>
Intel Turbo Boost Technology	
Enable Intel Turbo Boost Technology	<p>Enables or disables the Intel TurboBoost mode of the processor. When enabled, the Intel TurboBoost driver increases the performance of the CPU or graphics processor.</p> <p>By default, the Enable Intel Turbo Boost Technology option is enabled.</p> <p>NOTE: To view this option, enable Advanced Setup mode as described in View Advanced Setup options.</p>

Table 44. System Setup options—Performance menu (continued)

Performance	
Intel Hyper-Threading Technology	
Enable Intel Hyper-Threading Technology	<p>Enables or disables the Intel Hyper-Threading mode of the processor. When enabled, the Intel Hyper-Threading increases the efficiency of the processor resources when multiple threads run on each core.</p> <p>By default, the Intel Hyper-Threading Technology option is enabled.</p> <p>i NOTE: To view this option, enable Advanced Setup mode as described in View Advanced Setup options.</p>
Dynamic Tuning: Machine Learning	
Enable Dynamic Tuning: Machine Learning	<p>Enables or disables operating system capability to enhance power tuning capabilities depending on the detected workloads.</p> <p>i NOTE: This option is available for development only and is not customer visible.</p> <p>By default, the Enable Dynamic Tuning: Machine Learning option is disabled.</p>

Table 45. System Setup options—System Logs menu

System Logs	
BIOS Event Log	
Clear BIOS Event Log	<p>Select the option to keep or clear BIOS events logs.</p> <p>By default, the Keep Log option is selected.</p> <p>i NOTE: To view this option, enable Advanced Setup mode as described in View Advanced Setup options.</p>
Thermal Event Log	
Clear Thermal Event Log	<p>Select the option to keep or clear Thermal events logs.</p> <p>By default, the Keep Log option is selected.</p> <p>i NOTE: To view this option, enable Advanced Setup mode as described in View Advanced Setup options.</p>
Power Event Log	
Clear Power Event Log	<p>Select the option to keep or clear Power events logs.</p> <p>By default, the Keep Log option is selected.</p> <p>i NOTE: To view this option, enable Advanced Setup mode as described in View Advanced Setup options.</p>

Updating the BIOS

Updating the BIOS in Windows

Steps

1. Go to [Dell Support Site](#).
2. Go to **Identify your product or search support**. In the box, enter the product identifier, model, service request or describe what you are looking for, and then click **Search**.

i **NOTE:** If you do not have the Service Tag, use the SupportAssist to automatically identify your computer. You can also use the product ID or manually browse for your computer model.

3. Click **Drivers & Downloads**. Expand **Find drivers**.
4. Select the operating system installed on your computer.
5. In the **Category** drop-down list, select **BIOS**.
6. Select the latest version of BIOS, and click **Download** to download the BIOS file for your computer.
7. After the download is complete, browse the folder where you saved the BIOS update file.
8. Double-click the BIOS update file icon and follow the on-screen instructions.

For more information about how to update the system BIOS, search in the Knowledge Base Resource at [Dell Support Site](#).

Updating the BIOS using the USB drive in Windows

Steps

1. Go to [Dell Support Site](#).
2. Go to **Identify your product or search support**. In the box, enter the product identifier, model, service request or describe what you are looking for, and then click **Search**.
 **NOTE:** If you do not have the Service Tag, use the SupportAssist to automatically identify your computer. You can also use the product ID or manually browse for your computer model.
3. Click **Drivers & Downloads**. Expand **Find drivers**.
4. Select the operating system installed on your computer.
5. In the **Category** drop-down list, select **BIOS**.
6. Select the latest version of BIOS, and click **Download** to download the BIOS file for your computer.
7. Create a bootable USB drive. For more information, search the Knowledge Base Resource at [Dell Support Site](#).
8. Copy the BIOS Setup program file to the bootable USB drive.
9. Connect the bootable USB drive to the computer that needs the BIOS update.
10. Restart the computer and press **F12**.
11. Select the USB drive from the **One Time Boot Menu**.
12. Type the BIOS Setup program filename and press **Enter**.
The **BIOS Update Utility** appears.
13. Follow the on-screen instructions to complete the BIOS update.

Updating the BIOS from the One-Time boot menu

You can run the BIOS flash update file from Windows using a bootable USB drive or you can also update the BIOS from the One-Time boot menu on the computer. To update your computers BIOS, copy the BIOS XXXX.exe file onto a USB drive formatted with the FAT32 file system. Then, restart your computer and boot from the USB drive using the One-Time Boot Menu.

About this task

BIOS Update

To confirm if the BIOS Flash Update is listed as a boot option you can boot your computer to the **One Time Boot Menu**. If the option is listed, then the BIOS can be updated using this method.

To update your BIOS from the One-Time boot menu, you need the following:

- USB drive formatted to the FAT32 file system (the drive does not have to be bootable)
- BIOS executable file that you downloaded from the Dell Support website and copied to the root of the USB drive
- AC power adapter must be connected to the computer
- A functional computer battery to flash the BIOS

Perform the following steps to update the BIOS from the One-Time boot menu:

 **CAUTION:** Do not turn off the computer during the BIOS flash update process. The computer may not boot if you turn off your computer.

Steps

1. Turn off the computer, insert the USB drive that contains the BIOS flash update file.
2. Turn on the computer and press **F12** to access the **One Time Boot** Menu. Select **BIOS Update** using the mouse or arrow keys then press Enter.
The flash BIOS menu is displayed.
3. Click **Flash from file**.
4. Select the external USB device.
5. Select the file and double-click the flash target file, and then click **Submit**.
6. Click **Update BIOS**. The computer restarts to flash the BIOS.
7. The computer will restart after the BIOS flash update is completed.

System and setup password

 **CAUTION:** The password features provide a basic level of security for the data on your computer.

 **CAUTION:** Ensure that your computer is locked when it is not in use. Anyone can access the data that is stored on your computer, when left unattended.

Table 46. System and setup password

Password type	Description
System password	Password that you must enter to boot to your operating system.
Setup password	Password that you must enter to access and change the BIOS settings of your computer.

You can create a system password and a setup password to secure your computer.

 **NOTE:** The System and setup password feature is disabled by default.

Assigning a System Setup password

Prerequisites

You can assign a new System or Admin Password only when the status is set to **Not Set**. To enter BIOS System Setup, press F2 immediately after a power-on or reboot.

Steps

1. In the **System BIOS** or **System Setup** screen, select **Security** and press Enter.
The **Security** screen is displayed.
2. Select **System/Admin Password** and create a password in the **Enter the new password** field.
Use the following guidelines to create the system password:
 - A password can have up to 32 characters.
 - A password can at least have one special character: "(! " # \$ % & ' * + , - . / : ; < = > ? @ [\] ^ _ ` { | })"
 - A password can have numbers 0 to 9.
 - A password can have an upper case letters from A to Z.
 - A password can have a lower case letters from a to z.
3. Type the system password that you entered earlier in the **Confirm new password** field and click **OK**.
4. Press Y to save the changes.
The computer restarts.

Deleting or changing an existing system password or setup password

Prerequisites

Ensure that the **Password Status** is Unlocked in the System Setup before attempting to delete or change the existing system password and/or setup password. You cannot delete or change an existing system password or setup password if the **Password Status** is Locked. To enter the System Setup, press F2 immediately after a power-on or reboot.

Steps

1. In the **System BIOS** or **System Setup** screen, select **System Security** and press Enter. The **System Security** screen is displayed.
2. In the **System Security** screen, verify that the **Password Status** is Unlocked.
3. Select **System Password**. Update or delete the existing system password, and press Enter or Tab.
4. Select **Setup Password**. Update or delete the existing setup password, and press Enter or Tab.

NOTE: If you change the system password and/or setup password, reenter the new password when prompted. If you delete the system password and/or setup password, confirm the deletion when prompted.

5. Press Esc. A message prompts you to save the changes.
6. Press Y to save the changes and exit from **System Setup**. The computer restarts.

Clearing Chassis Intrusion Alert

The system features a chassis intrusion switch which can detect whenever the base cover has been removed from the system. Alerts to notify you of any intrusions can be enabled through the **Chassis Intrusion** field in the **Security** sub-menu of the BIOS setup menu.

When enabled, the **Block Boot Until Cleared** field allows you to choose whether to prevent normal boot up of the system until the intrusion alert is cleared.

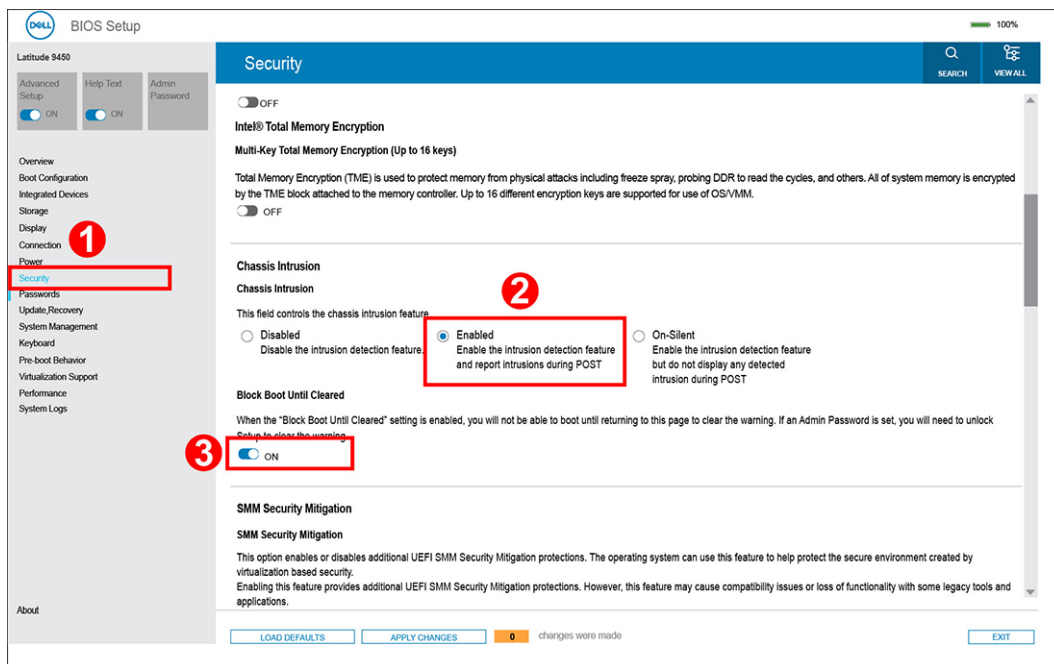

Figure 70. Security tab

- If **Block Boot Until Cleared** is set to **ON**, the user must select BIOS-Setup and clear the intrusion alert in order to boot.

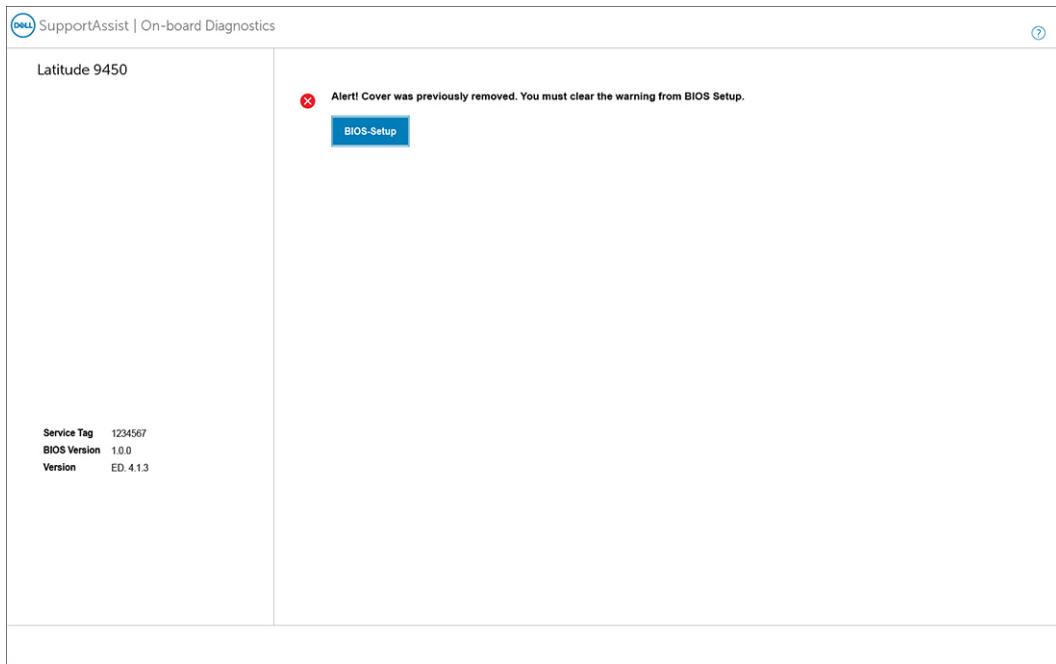

Figure 71. Block Boot Until Cleared is set to ON

- If **Block Boot Until Cleared** is set to **OFF**, select **Continue** to boot or **BIOS-Setup** to clear the alert.

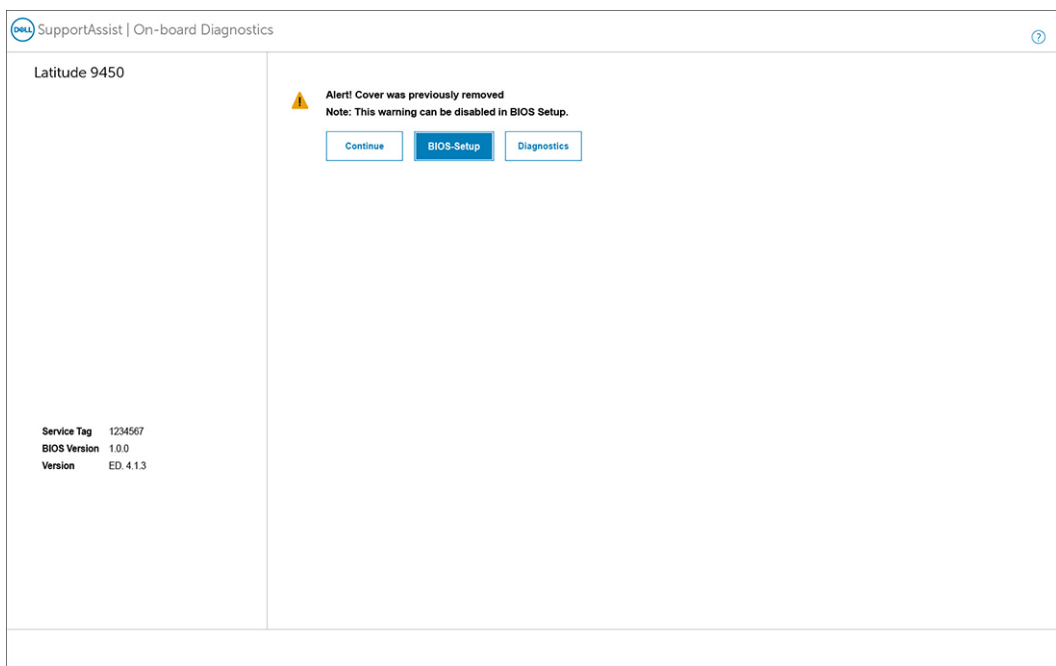

Figure 72. Block Boot Until Cleared is set to OFF

NOTE: If **Continue** is selected, the user continues to see the alert each time the system is powered on until the alert is cleared.

To clear the alert, select **ON** in the **Clear Intrusion Warning** field in the **Security** sub-menu of the BIOS setup menu.

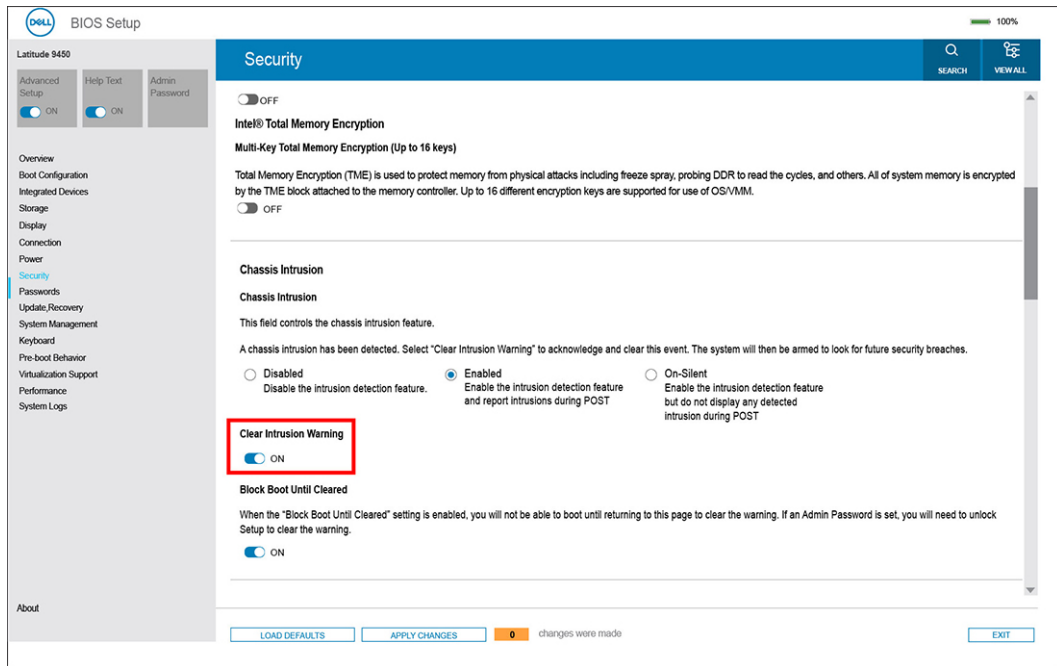

Figure 73. Clear Intrusion Warning

Clearing CMOS settings

About this task

CAUTION: Clearing CMOS settings resets the BIOS settings on your computer.

Steps

1. Remove the [base cover](#).
2. Remove the [battery](#).
3. Wait for one minute.
4. Replace the [battery](#).
5. Replace the [base cover](#).

Clearing system and setup passwords

About this task

To clear the system or setup passwords, contact Dell technical support as described at [Contact Support](#).

NOTE: For information about how to reset Windows or application passwords, see the documentation accompanying Windows or your application.

Troubleshooting

Handling swollen rechargeable Li-ion batteries

Like most laptops, Dell laptops use Lithium-ion batteries. One type of Lithium-ion battery is the rechargeable Li-ion battery. Rechargeable Li-ion batteries have increased in popularity in recent years and have become a standard in the electronics industry due to customer preferences for a slim form factor (especially with newer ultra-thin laptops) and long battery life. Inherent to rechargeable Li-ion battery technology is the potential for swelling of the battery cells.

A swollen battery may impact the performance of the laptop. To prevent possible further damage to the device enclosure or internal components leading to malfunction, discontinue the use of the laptop and discharge it by disconnecting the AC adapter and letting the battery drain.

Swollen batteries should not be used and must be replaced and disposed of properly. We recommend contacting Dell Support for options to replace a swollen battery under the terms of the applicable warranty or service contract, including options for replacement by a Dell authorized service technician.

The guidelines for handling and replacing rechargeable Li-ion batteries are as follows:

- Exercise caution when handling rechargeable Li-ion batteries.
- Discharge the battery before removing it from the laptop. To discharge the battery, unplug the AC adapter from the computer and operate the computer only on battery power. The battery is fully discharged when the computer no longer turns on when the power button is pressed.
- Do not crush, drop, mutilate, or penetrate the battery with foreign objects.
- Do not expose the battery to high temperatures, or disassemble battery packs and cells.
- Do not apply pressure to the surface of the battery.
- Do not bend the battery.
- Do not use tools of any type to pry on or against the battery.
- If a battery gets stuck in a device as a result of swelling, do not try to free it as puncturing, bending, or crushing a battery can be dangerous.
- Do not attempt to reassemble a damaged or swollen battery into a laptop.
- Swollen batteries that are covered under warranty should be returned to Dell in an approved shipping container (provided by Dell)—this is to comply with transportation regulations. Swollen batteries that are not covered under warranty should be disposed of at an approved recycling center. Contact Dell Support at [Dell Support Site](#) for assistance and further instructions.
- Using a non-Dell or incompatible battery may increase the risk of fire or explosion. Replace the battery only with a compatible battery purchased from Dell that is designed to work with your Dell computer. Do not use a battery from other computers with your computer. Always purchase genuine batteries from [Dell Site](#) or otherwise directly from Dell.

Rechargeable Li-ion batteries can swell for various reasons such as age, number of charge cycles, or exposure to high heat. For more information about how to improve the performance and lifespan of the laptop battery and to minimize the possibility of occurrence of the issue, search Dell laptop battery in the Knowledge Base Resource at [Dell Support Site](#).

Locating the Service Tag or Express Service Code of your Dell computer

Your Dell computer is uniquely identified with a Service Tag or Express Service Code. To view relevant support resources for your Dell computer, we recommend entering the Service Tag or Express Service Code at [Dell Support Site](#).

For more information about how to find the Service Tag for your computer, see [Instructions on how to find your Service Tag or Serial Number](#).

Dell SupportAssist Pre-boot System Performance Check diagnostics

About this task

SupportAssist diagnostics (also known as system diagnostics) performs a complete check of your hardware. The Dell SupportAssist Pre-boot System Performance Check diagnostics is embedded within the BIOS and launched by the BIOS internally. The embedded system diagnostics provides options for particular devices or device groups allowing you to:

- Run tests automatically or in an interactive mode.
- Repeat the tests.
- Display or save test results.
- Run thorough tests to add more options and obtain details about any failed devices.
- View status messages that inform you when the tests are completed successfully.
- View error messages that inform you of problems encountered during testing.

 **NOTE:** Some tests for specific devices require user interaction. Always ensure that you are present at the computer when the diagnostic tests are performed.

For more information, see the knowledge base article [000181163](#).

Running the SupportAssist Pre-Boot System Performance Check

Steps

1. Turn on your computer.
2. As the computer boots, press the F12 key.
3. On the boot menu screen, select **Diagnostics**.
The diagnostic quick test begins.

 **NOTE:** For more information about running the SupportAssist Pre-Boot System Performance Check on a specific device, see [Dell Support Site](#),

4. If there are any issues, error codes are displayed.
Note the error code and validation number and contact Dell.

Built-in self-test (BIST)

M-BIST

M-BIST (Built In Self-Test) is the system board built-in self-test diagnostics tool that improves the diagnostics accuracy of system board Embedded Controller (EC) failures.

 **NOTE:** M-BIST can be manually initiated before Power On Self-Test (POST).

How to run M-BIST

 **NOTE:** Before initiating M-BIST, ensure that the computer is in a power-off state.

1. Press and hold both the **M** key on the keyboard and the power button to initiate M-BIST.
2. The battery indicator LED may exhibit two states:
 - a. OFF: No fault was detected with the system board.
 - b. AMBER: Amber indicates a problem with the system board.
3. If there is a failure with the system board, the battery status LED flashes one of the following error codes for 30 seconds:

Table 47. LED error codes

Blinking Pattern		Possible Problem
Amber	White	
2	1	CPU failure
2	8	LCD failure (EC detection of power rail failure)
1	1	TPM detection failure
3	6	MBIST SPI test failure

4. If there is no failure with the system board, the LCD cycles through the solid color screens that are described in the LCD-BIST section for 30 seconds and then turn off.

Logical Built-in Self-test (L-BIST)

L-BIST is an enhancement to the single LED error code diagnostics and is automatically initiated during POST. L-BIST will check the LCD power rail. If there is no power being supplied to the LCD (that is if the L-BIST circuit fails), the battery status LED flashes either an error code [2,8] or an error code [2,7].

 **NOTE:** If L-BIST fails, LCD-BIST cannot function as no power will be supplied to the LCD.

How to invoke the L-BIST

1. Turn on your computer.
2. If the computer does not start up normally, look at the battery status LED:
 - If the battery status LED flashes an error code [2,7], the display cable may not be connected properly.
 - If the battery status LED flashes an error code [2,8], there is a failure on the LCD power rail of the system board, hence there is no power that is supplied to the LCD.
3. For cases, when a [2,7] error code is shown, check to see if the display cable is properly connected.
4. For cases when a [2,8] error code is shown, replace the system board.

LCD Built-in Self-Test (LCD-BIST)

Dell laptops have a built-in diagnostic tool that helps you determine if the screen abnormality you are experiencing is an inherent problem with the LCD (screen) of the Dell laptop or with the video card (GPU) and computer settings.

When you notice screen abnormalities like flickering, distortion, clarity issues, fuzzy or blurry image, horizontal or vertical lines, color fade, it is always a good practice to isolate the LCD (screen) by running the LCD-BIST.

How to invoke the LCD-BIST

1. Turn off your computer.
2. Disconnect any peripherals that are connected to the computer. Connect only the AC adapter (charger) to the computer.
3. Ensure that the LCD (screen) is clean (no dust particles on the surface of the screen).
4. Press and hold the **D** key and press the power button to enter LCD-BIST mode. Continue to hold the **D** key until the computer boots up.
5. The screen displays solid colors and changes colors on the entire screen to white, black, red, green, and blue twice.
6. Then it displays the colors white, black, and red.
7. Carefully inspect the screen for abnormalities (any lines, fuzzy color, or distortion on the screen).
8. At the end of the last solid color (red), the computer shuts down.

 **NOTE:** Dell SupportAssist Preboot diagnostics upon launch initiates an LCD-BIST first, expecting a user intervention to confirm functionality of the LCD.

System-diagnostic lights

This section lists the system-diagnostic lights of your Latitude 9450 2-in-1.

NOTE: The battery-status light indicator shows the system-diagnostic light codes.

Table 48. System-diagnostic lights

Blinking pattern		Problem description	Suggested resolution
Amber	White		
1	1	TPM detection failure	Replace the system board.
1	2	Unrecoverable SPI Flash Failure	Replace the system board.
1	5	EC unable to program i-Fuse	Replace the system board.
1	6	Generic catch-all for ungraceful EC code flow errors	Disconnect all power source (AC, battery, coin cell) and drain flea power by pressing and holding down the power button for 3~5 seconds.
2	1	CPU failure	<ul style="list-style-type: none"> Run the Dell SupportAssist or Dell Diagnostics tool. If the problem persists, replace the system board.
2	2	System board failure (included BIOS corruption or ROM error)	<ul style="list-style-type: none"> Flash latest BIOS version If the problem persists, replace the system board.
2	3	No memory or RAM detected	<ul style="list-style-type: none"> Confirm that the memory module is installed properly. If the problem persists, replace the memory module.
2	4	Memory or RAM failure	<ul style="list-style-type: none"> Reset and swap memory modules among the slots. If the problem persists, replace the memory module.
2	5	Invalid memory installed	<ul style="list-style-type: none"> Reset and swap memory modules among the slots. If the problem persists, replace the memory module.
2	6	System board or Chipset Error	Replace the system board.
2	7	LCD failure (SBIOS message)	Replace the LCD module.
2	8	LCD failure (EC detection of power rail failure)	Replace the system board.
3	1	CMOS battery failure	<ul style="list-style-type: none"> Reset the main battery connection. If the problem persists, replace the main battery.

Table 48. System-diagnostic lights (continued)

Blinking pattern		Problem description	Suggested resolution
Amber	White		
3	2	PCI or Video card or chip failure	Replace the system board.
3	3	BIOS Recovery image not found	<ul style="list-style-type: none"> Flash latest BIOS version If the problem persists, replace the system board.
3	4	BIOS Recovery image found but invalid	<ul style="list-style-type: none"> Flash latest BIOS version If the problem persists, replace the system board.
3	5	Power rail failure	Replace the system board.
3	6	Flash corruption is detected by SBIOS.	<ul style="list-style-type: none"> Press the power button for over 25 seconds to do RTC reset. If the problem persists, replace the system board. Disconnect all power source (AC, battery, coin cell) and drain flea power by pressing and holding down the power button 3~5 seconds to ensure all power are drained. Run "BIOS recovery from USB", and the instructions are in the website Dell support. If the problem persists, replace the system board.
3	7	Timeout waiting on ME to reply to HECI message.	Replace the system board.

NOTE: Blinking 3-3-3 LEDs on Lock LED (Caps-Lock or Num-Lock), Power button LED (without Fingerprint reader), and Diagnostic LED indicates failure to provide input during LCD panel test on Dell SupportAssist Pre-boot System Performance Check diagnostics.

Recovering the operating system

When your computer is unable to boot to the operating system even after repeated attempts, it automatically starts Dell SupportAssist OS Recovery.

Dell SupportAssist OS Recovery is a stand-alone tool that is preinstalled in Dell computers running the Windows operating system. It consists of tools to diagnose and troubleshoot issues that may occur before your computer boots to the operating system. It enables you to diagnose hardware issues, repair your computer, back up your files, and restore your computer to its factory state.

You can also download it from the Dell Support website to troubleshoot and fix your computer when it fails to boot into the primary operating system due to software or hardware failures.

For more information about the Dell SupportAssist OS Recovery, see *Dell SupportAssist OS Recovery User's Guide at Serviceability Tools at the Dell Support Site*. Click **SupportAssist** and then click **SupportAssist OS Recovery**.

Real-Time Clock (RTC Reset)

The Real-Time Clock (RTC) reset function allows you or the service technician to recover Dell computers from No POST/No Power/No Boot situations. The legacy jumper enabled RTC reset has been retired on these models.

Start the RTC reset with the computer powered off and connected to AC power. Press and hold the power button for thirty (30) seconds

The computer RTC Reset occurs after you release the power button.

Backup media and recovery options

It is recommended to create a recovery drive to troubleshoot and fix problems that may occur with Windows. Dell Technologies proposes multiple options for recovering the Windows operating system on your Dell computer. For more information, see [Dell Windows Backup Media and Recovery Options](#).

Wi-Fi power cycle

About this task

If your computer is unable to access the Internet due to Wi-Fi connectivity issues, a Wi-Fi power cycle procedure may be performed. The following procedure provides the instructions on how to perform a Wi-Fi power cycle:

 **NOTE:** Some Internet Service Providers (ISPs) provide a modem or router combo device.

Steps

1. Turn off your computer.
2. Turn off the modem.
3. Turn off the wireless router.
4. Wait for 30 seconds.
5. Turn on the wireless router.
6. Turn on the modem.
7. Turn on your computer.

Drain residual flea power (perform hard reset)

About this task

Flea power is the residual static electricity that remains in the computer even after it has been powered off and the battery is removed.

For your safety, and to protect the sensitive electronic components in your computer, you must drain the residual flea power before removing or replacing any components in your computer.

Draining residual flea power, also known as a performing a "hard reset", is also a common troubleshooting step if your computer does not turn on or boot into the operating system.

Procedure to drain residual flea power (perform a hard reset)

Steps

1. Turn off your computer.
2. Disconnect the power adapter from your computer.
3. Remove the base cover.
4. Remove the battery.
5. Press and hold the power button for 20 seconds to drain the flea power.
6. Install the battery.

7. Install the base cover.
8. Connect the power adapter to your computer.
9. Turn on your computer.

 **NOTE:** For more information about performing a hard reset, search in the Knowledge Base Resource at [Dell Support site](#).

Getting help and contacting Dell

Self-help resources

You can get information and help on Dell products and services using these self-help resources:

Table 49. Self-help resources

Self-help resources	Resource location
Information about Dell products and services	Dell Site
Tips	
Contact Support	In Windows search, type <code>Contact Support</code> , and press Enter.
Online help for operating system	Windows Support Site
Access top solutions, diagnostics, drivers and downloads, and learn more about your computer through videos, manuals, and documents.	Your Dell computer is uniquely identified by a Service Tag or Express Service Code. To view relevant support resources for your Dell computer, enter the Service Tag or Express Service Code at Dell Support Site . For more information about how to find the Service Tag for your computer, see Instructions on how to find your Service Tag or Serial Number .
Dell knowledge base articles	<ol style="list-style-type: none"> 1. Go to Dell Support Site. 2. On the menu bar at the top of the Support page, select Support > Support Library. 3. In the Search field on the Support Library page, type the keyword, topic, or model number, and then click or tap the search icon to view the related articles.

Contacting Dell

To contact Dell for sales, technical support, or customer service issues, see [Contact Support at Dell Support Site](#).

 **NOTE:** Availability of the services may vary depending on the country or region, and product.

 **NOTE:** If you do not have an active Internet connection, you can find contact information about your purchase invoice, packing slip, bill, or Dell product catalog.